

2021

promosolution
advertising & gadget

2022

1

GRANDI FIRME
THE BRIDGE
LACROIX
HUGO BOSS
CERRUTI
UNGARO
CACHAREL
LAVILLE PARIS
BOUQUET DE PROVENCE
VERY

37

BORSE & VALIGE
TROLLEY
BORSE DA VIAGGIO
ZAINI PORTA PC
VALIGIE
TRACOLLE

47

AGENDE
AGENDE IN PELLE
AGENDE IN SIMILPELLE
AGENDE BLOCCO FISSO
AGENDE IN VIVELLA
AGENDINE TASCABILI
PLANNING CON SPIRALE

83

MEETING&NOTES
CARTELLE
PORTADOCUMENTI
CARTELLE PORTA PC
ZAINI PORTA PC
CARTELLE SOTTOBRACCIO
CARTELLE PORTABLOCCO
TACCUINI
NOTES

105

CALENDARI
CALENDARI DA PARETE
CALENDARI DA TAVOLO
PLANNING

167

PENNE
PENNE IN METALLO
PENNE IN PLASTICA
PENNE DA BANCO
MATITE
SET COLORI
ASTUCCI PORTAPENNE

215

ACCENDINI
ACCENDINI IN PLASTICA
ACCENDINI IN METALLO
ACCENDIGAS
POSACENERE

223

PORTACHIAVI
PORTACHIAVI IN METALLO
PORTACHIAVI IN SIMILPELLE
PORTACHIAVI CON LED
PORTACHIAVI CON GETTONE
LANYARD
PORTABADGE
BRACCIALETTI

237

HI-TEC
SPEAKER
POWER BANK
CHIAVETTE USB
AURICOLARI
CAVI RICARICA
PORTACHIAVI TOUCH

245

TIME&OFFICE
OROLOGI DA PARETE
PORTAPENNE
CALCOLATRICI
TAPPETINO MOUSE

253

SHOPPER
SHOPPER IN TNT
SHOPPER IN COTONE
SHOPPER IN PLP
SHOPPER RICHIUDIBILI

275

WINE&HOME
TAZZE
BICCHIERI
APRIBOTTIGLIA
PORTABOTTIGLIE
PORTA CALICE
GREMBIULI
CONTENITORE CIBO
TAGLIAPIZZA

289

BEAUTY
SPECCHIETTI
SPAZZOLE
SET MANICURE
LIMA PER UNGHIE
PINZETTA
VENTAGLIO
BEAUTY
PENNA ROSSETTO

297

OMBRELLI
OMBRELLI GOLF
OMBRELLI MANICO LEGNO
OMBRELLI PIEGHEVOLI

307

TERMOSALDATI
PORTACARD
PORTALOTTO
PORTARICETTE
PORTABIGLIETTO AEREO
PORTANOME VALIGE

317

AUTO&MOTO
PORTADOCUMENTI
PORTASSICURAZIONI
PORTATARGA
PORTAPOLIZZA
DISCO ORARIO

325

UTILITY
FLESSOMETRI
DOPPIO METRO
MATITA FALEGNAME
TAGLIERINI
ARTICOLI FARMACEUTICI
TORCE
CALZASCARPE

333

ZAINI&SPORTBAG
ZAINI PORTA PC
ZAINI TEMPO LIBERO
ZAINI CAMOUFLAGE
BORSONI SPORT
BORSA TERMICA

355

TEMPO LIBERO
BORRACCE
BICCHIERI
BORSA MARE
VENTAGLIO
OCCHIALI DA SOLE
COPERTA IN PILE
STUOIA
GIOCHI MARE
BRACCIALETTI

367

ABBIGLIAMENTO
T-SHIRT
POLO
FELPE
GILET
GIUBBINI
PILE
GREMBIULI
WORK
CAPPELLINI
SCALDACOLLO



GRANDI FIRME

promosolution
2021|2022

GRANDI FIRME

**THE BRIDGE**

ZAINO IN PELLE

*tasca imbottita
portacomputer*

CHIUSURE CON ZIP
E MAGNETICHE



AB 0205 ZAINO

in pelle bovina conciata al vegetale tinta a mano, chiusura a zip con doppio cursore, tasca portacomputer imbottita, tre tasche esterne di cui una con chiusura a zip e due con chiusura a calamita. Made in Italy.



Pelle



39 x 28 x 10 cm



1

**398,00**



CARTELLE PORTADOCUMENTI/PC
doppi manici e tracolle rimovibili
SCOMPARTI IMBOTTITI



GRANDI FIRME

THE BRIDGE

**AB 0192
 CARTELLA
 PORTADOCUMENTI/PC**

in pelle bovina conciata al vegetale tinta a mano, doppio manico, chiusura a zip con doppio cursore, tasca interna portacomputer imbottita, due tasche esterne con chiusura a calamita, dotata di tracolla rimovibile. Made in Italy.

-  Pelle
-  39 x 31 x 8,5 cm
-  1
-  **429,00**



**AB 0195
 CARTELLA
 PORTADOCUMENTI**

Cartella professionale in pelle bovina conciata al vegetale, tinta a mano, ampio scomparto principale con doppia tasca imbottita porta computer e porta tablet, chiusura a zip con doppio cursore. Doppia tasca esterna con chiusura a fibbia. Doppio manico e tracolla rimovibile. Made in Italy.

-  Pelle
-  38 x 28,5 x 12 cm
-  1
-  **468,00**

GRANDI FIRME



THE BRIDGE



AB 0289 TRACOLLA

In pelle bovina conciata al vegetale tinta a mano, scomparto principale con cerniera, tasca interna portaocchiali, porta cellulare, porta penna, tasca esterna con zip. Made in Italy.

-  Pelle
-  22,5 x 25 x 7 cm
-  1
-  **279,00**



AB 0290 TRACOLLA

In pelle bovina conciata al vegetale tinta a mano, scomparto principale con cerniera, tasca interna porta tablet, portaocchiali, porta cellulare, tasca esterna con zip. Made in Italy.

-  Pelle
-  22,5 x 25 x 4 cm
-  1
-  **249,00**







AB 0284 BEAUTY CASE

Beauty case in pelle bovina conciata al vegetale tinta a mano, chiusura con zip. Made in Italy.

-  Pelle
-  26 x 18 x 15 cm
-  1
-  **215,00**

AB 0245 PORTAFOGLI UOMO

In pelle bovina conciata al vegetale tinta a mano, chiusura a zip, varie tasche esterne e scomparti porta carte di credito su entrambi i lati. Made in Italy.

-  Pelle
-  12,5 x 9,5 x 1 cm
-  1
-  **85,00**



GRANDI FIRME

THE BRIDGE

AB 0241 PORTAFOGLI UOMO

In pelle bovina conciata al vegetale tinta a mano, varie tasche interne e scomparti porta carte di credito, tasca porta monete con chiusura a zip. Made in Italy.

-  Pelle
-  25 x 9,5 x 1 cm
-  1
-  **115,00**



AB 0274 CINTURA UOMO

Cintura in vera pelle bovina con fibbia in metallo lucido. Made in Italy.

-  Pelle
-  110 x 4 cm
-  1
-  **89,00**





AB 0235 PORTAFOGLI UOMO

In pelle bovina conciata al vegetale tinta a mano, varie tasche interne porta carte di credito, tasca porta monete. Made in Italy.

-  Pelle
-  11 x 9,5 x 1 cm
-  1
-  **76,00**

THE BRIDGE



AB 0236 PORTAFOGLI UOMO

In pelle bovina conciata al vegetale tinta a mano, varie tasche interne porta carte di credito. Made in Italy.

-  Pelle
-  11 x 9 x 1 cm
-  1
-  **69,00**

THE BRIDGE



AB 0240 PORTA CARTE DI CREDITO

In pelle bovina conciata al vegetale tinta a mano, varie tasche interne. Made in Italy.

-  Pelle
-  9 x 10 x 1 cm
-  1
-  **59,00**







**AB 0265
MOUSE PAD**

In pelle bovina conciata al vegetale tinta a mano. Made in Italy.

-  Pelle
-  20 x 24 cm
-  1
-  **65,00**



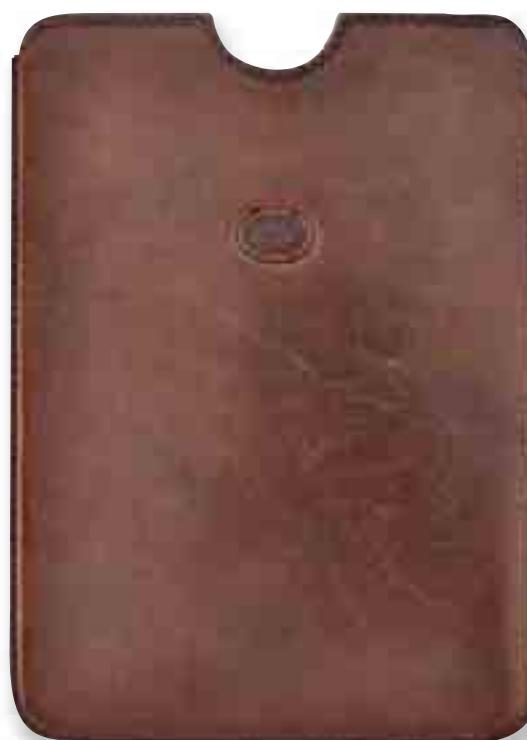

**AB 0250
PORTA IPAD**

In pelle bovina conciata al vegetale tinta a mano. Made in Italy.

-  Pelle
-  21,4 x 25,6 cm
-  1
-  **115,10**

**AB 0283
NECESSAIRE**

In pelle bovina conciata al vegetale tinta a mano, con chiusura a zip. Made in Italy.

-  Pelle
-  23x14
-  1
-  **87,00**



GRANDI FIRME

THE BRIDGE

GRANDI FIRME

THE BRIDGE

ZAINO
 IN CANVAS E PELLE
doppio scomparto interno
TASCA PER COMPUTER IMBOTTITA

AB 0185
ZAINO

Zaino in canvas con finiture in pelle bovina conciata al vegetale tinta a mano, due scomparti con chiusura zip a doppio cursore, tasca interna portacomputer imbottita, tasca esterna con chiusura a calamita, portabottiglia laterale rimovibile. Made in Italy.

-  Canvas e Pelle
-  43 x 30 x 12 cm
-  1
-  **290,00**



ZAINO
 IN CANVAS E PELLE
chiusura zip doppio cursore
 TASCA PER COMPUTER IMBOTTITA



GRANDI FIRME

THE BRIDGE



AB 0180
ZAINO

Zaino in canvas con finiture in pelle bovina conciata al vegetale tinta a mano, chiusura zip a doppio cursore, tasca interna portacomputer imbottita, tasca esterna con chiusura a calamita. Made in Italy.

	Canvas e Pelle
	43 x 30 x 11 cm
	1
	265,00

GRANDI FIRME



THE BRIDGE

AB 0196 CARTELLA PORTADOCUMENTI

Cartella professionale in pelle bovina conciata al vegetale, tinta a mano, ampio scomparto principale con doppia tasca imbottita porta computer e porta tablet, chiusura a zip con doppio cursore. Doppia tasca esterna con chiusura a zip. Doppio manico e tracolla rimovibile. Made in Italy.

-  Pelle
-  38 x 28 x 6,5 cm
-  1
-  **395,00**



AB 0197 TRACOLLA PORTADOCUMENTI

Tracolla in pelle bovina conciata al vegetale tinta a mano, chiusura a zip con doppio cursore, due tasche esterne con chiusura a calamita. Made in Italy.

-  Pelle
-  32 x 25 x 8 cm
-  1
-  **265,00**

ZAINO IN PELLE

chiusura zip doppio cursore

SCOMPARTO IMBOTTITO PER COMPUTER



GRANDI FIRME

**THE BRIDGE**

AB 0210 ZAINO



Zaino in pelle bovina conciata al vegetale tinta a mano, due scomparti con chiusura a zip con doppio cursore, scomparto principale con tasca portacomputer imbottita, scomparto secondario con due tasche portaoggetti. Made in Italy.

	Pelle
	30 x 40 x 12 cm
	1
	490,00



AB 0244 PORTAFOGLI UOMO

In pelle bovina conciata al vegetale tinta a mano, 2 tasche porta banconote e 8 tasche porta carte di credito . Made in Italy.

-  Pelle
-  11 x 9 x 1 cm
-  1
-  **79,00**

THE BRIDGE



AB 0246 PORTA CARTE DI CREDITO

In pelle bovina conciata al vegetale tinta a mano, 2 tasche grandi e 6 tasche portacarte di credito . Made in Italy.

-  Pelle
-  12 x 9 cm
-  1
-  **75,00**

THE BRIDGE



AB 0245 PORTAFOGLI UOMO

In pelle bovina conciata al vegetale tinta a mano, chiusura a zip, varie tasche esterne e scomparti porta carte di credito su entrambi i lati. Made in Italy.

-  Pelle
-  12,5 x 9,5 x 1 cm
-  1
-  **85,00**

AB 0275 CINTURA UOMO

Cintura in vera pelle bovina con fibbia in metallo lucido. Made in Italy.

-  Pelle
-  110 x 4 cm
-  1
-  **89,00**







GRANDI FIRME

THE BRIDGE

AB 0305 PORTACHIAVI

In pelle bovina conciata al vegetale tinta a mano con particolari in acciaio. Made in Italy.

-  Pelle
-  10x2 cm
-  1
-  **45,00**



AB 0306 PORTACHIAVI

In pelle bovina conciata al vegetale tinta a mano con particolari in acciaio. Made in Italy.

-  Pelle
-  10 x 4 cm
-  1
-  **45,00**



AB 0298 PORTACHIAVI

In pelle bovina conciata al vegetale tinta a mano con particolari in acciaio. Made in Italy.

-  Pelle
-  15x3 cm.
-  1
-  **49,00**



GRANDI FIRME



THE BRIDGE

**BORSA
DA DONNA
IN PELLE**
completa
di pochette
interna

DOPPIO
MANICO
TRACOLLA
RIMOVIBILE



**AB 0190
BORSA DONNA**

Borsa in pelle bovina conciata al vegetale tinta a mano con pochette interna inclusa, doppio manico, chiusura con linguetta, dotata di tracolla rimovibile. Made in Italy.



Pelle



36 x 26 x 16 cm



1



395,00

**BORSA
DA DONNA
IN PELLE**
**completa
di pochette
interna**



GRANDI FIRME

THE BRIDGE



**AB 0189
BORSA DONNA**

Borsa in pelle bovina conciata al vegetale tinta a mano con pochette interna inclusa, doppio manico, chiusura con linguetta, dotata di tracolla rimovibile. Made in Italy.

-  Pelle
-  36 x 26 x 16 cm
-  1
-  **335,00**

GRANDI FIRME



THE BRIDGE



AB 0208 BORSA DONNA PORTADOCUMENTI

Borsa donna in pelle bovina conciata al vegetale, doppio manico, chiusura con zip, dotata di tracolla. Made in Italy.

 Pelle

 50 x 34 x 4 cm

 1

 **398,00**



AB 0211 CARTELLA PORTADOCUMENTI

Professionale in pelle bovina conciata al vegetale tinta a mano, doppio manico, scomparto principale con cerniera, tasca interna porta computer, portapenna, portaocchiali e porta cellulare, tracolla rimovibile, Made in Italy.

 Pelle

 40 x 31 x 15 cm

 1

 **448,00**





GRANDI FIRME

THE BRIDGE

AB 0207 BORSA DONNA

Borsa con tracolla in pelle bovina conciata al vegetale tinta a mano, pattina frontale e chiusura con bottone automatico, tasca interna con zip. Made in Italy.

-  Pelle
-  23,5 x 21 x 9 cm
-  1
-  **335,00**

AB 0212 ZAINETTO DONNA

Zaino in pelle bovina conciata al vegetale tinta a mano, pattina frontale e chiusura con passante, tasca interna con zip. Made in Italy.

-  Pelle
-  26 x 32 x 15 cm
-  1
-  **395,00**



GRANDI FIRME



THE BRIDGE



AB 0225 PORTAFOGLI DONNA





In pelle bovina conciata al vegetale tinta a mano, 2 scomparti interni, chiusura con zip. Made in Italy.

-  Pelle
-  18 x 11 x 2 cm
-  1
-  **139,00**



AB 0226 PORTAFOGLI DONNA





In pelle bovina conciata al vegetale tinta a mano, 2 scomparti interni più tasca con zip, pattina porta tessere. Made in Italy.

-  Pelle
-  17 x 10,5 x 2,5 cm
-  1
-  **148,00**



AB 0220 NECESSAIRE

in pelle bovina conciata al vegetale tinta a mano, chiusura con zip, manico Made in Italy.

-  Pelle
-  21x12x,5 cm
-  1
-  **88,00**

AB 0206 BORSA DONNA

Borsa in canvas con finiture in pelle bovina conciata al vegetale tinta a mano, tracollina regolabile. Made in Italy.





-  Pelle
-  25 x 18 x 8 cm
-  1
-  **149,00**



BORSA DA DONNA *con tracolla regolabile*

AB 0224 PORTAFOGLI DONNA

in pelle bovina conciata al vegetale tinta a mano, 2 scomparti interni più tasca con zip, pattina porta tessere. Made in Italy.

-  Pelle
-  17 x 10,5 x 2,5 cm
-  1
-  **139,00**

PORTAFOGLI DONNA *2 scomparti più tasca con zip*







GRANDI FIRME

HUGO BOSS

BORRACCIA IN ACCIAIO DOPPIO SPESSORE DALLA COLLEZIONE GEAR MATRIX

AB 0380 BORRACCIA

Della collezione Gear Matrix Hugo Boss, realizzata in acciaio AISI304 doppio spessore per ottenere una performance da 24h freddo e 12h caldo. Tappo a vite in silicone ABS resistente alle alte temperature. **Capacità 500 ml.** Confezionato in scatola regalo Hugo Boss.

-  Acciaio AISI304
-  Ø 6,7 x H 26,5 cm
-  1
-  **39,90**



ELEVATE PRESTAZIONI
PER 24H FREDDO 12H CALDO





TAPPO A VITE IN SILICONE ABS
RESISTENTE AD ALTE TEMPERATURE

CONFEZIONATO IN SCATOLA
REGALO HUGO BOSS.



AB 0385 AURICOLARI

Auricolari di ultima generazione della collezione Gear Matrix di Hugo Boss, 6 ore di carica con Case da ricarica 28 ore. Chipset di ultima generazione "ultra clear sound" JL2697. Funzionalità haptic touch per rispondere/interrompere telefonate direttamente dall'auricolare e funzione di start/stop della musica. Ricarica USB-C o ricarica wireless con Qi technology. Funzione di noise cancellation. Doppio microfono per ogni auricolare. Confezionato in scatola regalo Hugo Boss.

-  ABS/Rubber
-  6,5 x 2,9 x h4,3 cm
-  1
-  **79,00**



GRANDI FIRME

HUGO BOSS

**AURICOLARI
DI ULTIMA
GENERAZIONE**
DALLA
COLLEZIONE
GEAR MATRIX







SPEAKER WIRELESS ACCOPPIA QUALSIASI DISPOSITIVO MOBILE IN SCATOLA REGALO HUGO BOSS



AB 0386 SPEAKER

Speaker ultima generazione della collezione Gear Matrix di Hugo Boss. Con la sua tecnologia di connettività wireless, accoppia qualsiasi dispositivo mobile e ascolta la tua musica o la tua radio preferita, rispondi a una chiamata ed effettua chiamate in conferenza con facilità senza dover usare il tuo cellulare. Confezionato in scatola regalo Hugo Boss.





-  Rubber
-  Ø 5,6 x H 6,6 cm
-  1
-  **44,00**

GRANDI FIRME

HUGO BOSS

**AB 0398
CARTELLA
PORTABLOCCO A4**

Cartella in poliuretano a grana grigia scura con targhetta Hugo Boss, vari scomparti interni porta biglietti da visita, dotata di blocco note, chiusura con zip.

-  Poliuretano
-  35,5 x 30 x 4,3 cm
-  1
-  **86,00**





**AB 0406
PORTACHIAVI**

Portachiavi HUGO BOSS in pelle gofrata con particolari in acciaio inossidabile. Confezione in astuccio.

-  Pelle
-  3,2 x 3 x 8 cm
-  1
-  **38,00**

**AB 0413
PORTACHIAVI**

Portachiavi realizzato in pelle liscia e di alta qualità impreziosito da un elegante "gemello" HUGO BOSS, realizzato in acciaio inossidabile. E' disponibile in nero e cromo lucido o in metallo black e opaco.

-  Pelle
-  8,5 x 3 cm
-  1
-  **38,00**









HUGO BOSS

AB 0408 AGENDA PERPETUA A5



Agenda in poliuretano con texture nera a grana morbida e dettagli in cromato lucido. Chiusura con elastico.

	Poliuretano
	21,3 x 15,3 x 1,4 cm
	1
	21,80



AB 0410 CARTELLA A4

Cartella portablocco HUGO BOSS in similpelle morbido, doppia tasca con chiusura a zip, blocco note incluso. Confezione in astuccio.

	Similpelle
	31 x 23,6 x 3,5 cm
	1
	78,00







GRANDI FIRME

CERRUTI 1881

**AB 0680
CARTELLA
PORTABLOCCO A4**

Cartella in morbida similpelle nera con logo Cerruti 1881 in metallo cromato. Dotata di blocco note interno, chiusura con zip. Confezionata in box regalo.

-  Similpelle
-  32,5 x 24,5 x 2,5 cm
-  1
-  **88,00**

**AB 0672
PORTACHIAVI CON USB**





Il portachiavi con USB **16 GB** della collezione "Hamilton" di CERRUTI 1881 è una grande idea regalo allo stesso tempo elegante e funzionale. Realizzato in pelle nei colori nero, blu scuro, tortora, stampato a grana e particolari in metallo cromato, viene confezionato in box CERRUTI 1881.

-  Pelle
-  23,5 x 21 x 9 cm
-  1
-  **48,00**



AB 0678 PORTACARD

Chiusura con zip, realizzato in pelle nera liscia accuratamente selezionata.

-  Pelle
-  11,3 x 9 cm
-  1
-  **42,00**



GRANDI FIRME

CERRUTI 1881

AB 0679 PORTACARD



Chiusura con zip, realizzato in pelle nera liscia accuratamente selezionata.

-  Pelle
-  13 x 7 cm
-  1
-  **42,00**



AB 0676 PORTAFOGLI UOMO

"Irving" CERRUTI 1881 realizzato in pelle accuratamente scelta, con una leggera grana e ornato da una piastra in acciaio inossidabile, vari scomparti porta carte di credito.



-  Pelle
-  11 x 9,5 x 1,4 cm
-  1
-  **69,00**



CERRUTI 1881

**AB 0645
BEAUTY CASE**

Bauty "Irving" di Cerruti 1881 lussuoso, compatto e semplice. Realizzati in morbida similpelle, strutturato e impreziosito dalla nuova targhetta CERRUTI 1881, la sua forma non è solo originale, ma è anche molto pratica.

-  Similpelle
-  23 x 11 x 11 cm
-  1
-  **44,00**



BEAUTY CASE IRVING

in morbida similpelle

**AB 0650
TRACOLLA**

Tracolla Hamilton di Cerruti 1881 realizzata in similpelle nera, chiusura con zip a doppio cursore, tasca esterna con zip, cinturino regolabile e amovibile.

-  Similpelle
-  26 x 21 x 5 cm
-  1
-  **58,00**





TRACOLLA HAMILTON

un classico in similpelle



**AB 0685
ZAINO**

Zaino poliestere CERRUTI 1881 con chiusura a doppia zip, scomparto con interno imbottito per tablet e computer portatile 15", connettore USB, due spallacci imbottiti e regolabili.

-  Poliestere
-  49 x 33 x 14 cm
-  1
-  **118,00**



CONNETTORE USB

GRANDI FIRME

CERRUTI 1881

ZAINO IN POLIESTERE

TASCA PER COMPUTER E TABLET IMBOTTITA





CHIUSURA DOPPIA ZIP



GRANDI FIRME

cacharel**AB 0791
BORSA DONNA**

Borsa "Isla" di Cacharel realizzata in morbida similpelle, dotata di due scomparti interni con chiusura a zip, tracolla rimovibile e adattabile.

-  Similpelle
-  30 x 22 x 14 cm
-  1
-  **118,00**



BORSA ISLA

REALIZZATA IN 2
ELEGANTI MODELLI

**AB 0792
BORSA DONNA**

Borsa "Isla" 2 in 1 di Cacharel realizzata in morbida similpelle. Rimuovendo la tracolla diventa una pochette o un portafoglio. Tracolla rimovibile e adattabile.

-  Similpelle
-  19,5 x 12 x 3 cm
-  1
-  **78,00**

AB 0799**OROLOGIO DA DONNA**

Della collezione "Madeleine" di Cacharel con cassa cromata abbinata ad un audace cinturino in pelle azzurra, con meccanismo Seiko.





-  Lega Zinco/Pelle
-  Dim quadr. Ø 38 mm
Lungh. 24 cm
-  1
-  **116,00**



GRANDI FIRME

cacharel**AB 0802****SET 3 POCLETTE**

Pochette realizzate in morbida similpelle beige sabbato, unite da un anello rimovibile placcato oro chiaro.

-  Similpelle
-  23,5 x 16,5 x 3,5 cm
-  1
-  **58,00**

**AB 0794**
FOULARD

Foulard realizzato in morbida e leggera lana impreziosita da una vibrante stampa a farfalla di colore blu scuro e giallo. Confezione in astuccio.

-  Lana
-  90 x 90 cm
-  1
-  **78,00**

**AB 0777**
FOULARD

Foulard "Madeleine" di Cacharel realizzato in seta finissima con stampa floreale. Confezione in astuccio.

-  Seta
-  65 x 65 cm
-  1
-  **48,00**





AB 0439 PROFUMATORE AMBIENTE

Assortito nelle fragranze Frisson - Voyager - Coucher - Printemps. Confezionato in box regalo. 200 ml.





-  Vetro e Legno
-  12 X 7 cm
-  1
-  € 26,00

VERY



AB 0494 PROFUMATORE AMBIENTE

50 ml Bouquet de Provence. Un profumatore con bastoncini in legno realizzati con essenze provenzali e presentato nell'elegante flacone "carré" da 50 ml. Fragranze Spezie d'Oriente (01) - Vaniglia e Patchouli (03) - Seta Pura e Legni (07). Confezionato in box regalo.



-  Vetro e Legno
-  4,5 x 8 cm
-  1
-  € 9,60

BOUQUET DE PROVENCE
1878
Maison de Parfum



AB 0458 PROFUMATORE 50 ML

Creato con l'utilizzo di fragranze francesi, contenuto in flacone di vetro con bastoncini in legno. Confezione in box regalo LAVILLE.

-  **Vetro e legno**
-  **8 x 4,5 cm**
-  **1**
-  **9,00**







GRANDI FIRME

LAVILLE PARIS

AB 0473 PORTACARD



In ecopelle nera. Confezionato in scatola di cartoncino Laville Paris.

-  **Ecopelle**
-  **10 x 7,5 cm**
-  **1**
-  **4,00**



AB 0483 PORTACHIAVI VESPA

Portachiavi in metallo nelle varianti cromo, oro e oro rosa. Confezionato in Gift box.

-  **Metallo**
-  **5X5 cm**
-  **1**
-  **3,00**





AB 0480 PALLINA DI NATALE

Per un Natale scintillante e luminoso! Una collezione di palle con decorazioni natalizie realizzato in Poli-Crystal trasparente che si illuminano rendendo magica l'atmosfera della vostra casa. Disponibile in 3 varianti assortite. Confezionate in scatola regalo

 Poli-Crystal

 Ø 8,5 cm

 1

 3,98 (cad.)



AB 0489 PORTACANDELE

LAVILLE PARIS ha creato questa collezione di portacandele in vetro sabbato che, al loro interno, hanno una speciale lamina in argento 925/1000 che permette alla candela di riflettere la luce. La collezione è composta da 4 modelli nei colori: bianco, argento, oro e ramato. Un accessorio per la vostra tavola.

 Vetro Sabbato

 Ø 10 cm

 1

 6,70

LAVILLE PARIS

AB 0460 SCIARPA

Lasciatevi conquistare dal calore avvolgente della sciarpa imbottita firmata Laville. La nuance si abbina a tutta la palette di stagione e aggiunge un tocco moderno alle vostre mise. Confezionata in sacchetto con chiusura a zip.

i Poliestere

o 85 x 11 cm

u 1

€ 8,00



GRANDI FIRME

LAVILLE PARIS



AB 0472 SET VIAGGIO

Set composto da borsone e beauty con chiusura a zip, realizzato in polycotton ecru, arricchito con ricamo stile "vintage" di LAVILLE PARIS.

i Polycotton

o Borsone: 49 x 34 x 20 cm
Beauty: 27 x 9 x 21 cm

u 1

€ 29,00



LAVILLE PARIS

SET VIAGGIO COMPOSTO DA *Borsone, Sacca e Beauty*



AB 0469 SET VIAGGIO 3 PZ

Un pratico tris viaggio, realizzato in polycotton two tone di colore grigio. Arricchito dalla stampa "Vintage" di LAVILLE PARIS. Il set è composto da:

- BORSONE con chiusura a cerniera e manici imbottiti.
- SACCA con chiusura a coulisse in corda e dotata di cinghia porta spalla.
- BEAUTY TERMICO con chiusura a cerniera.

 Polycotton

 Borsone : 49 x 34 x 20 cm
Sacca: 50 x 30 cm
Beauty: 22,5 x 14 x 15 cm

 1

 34,00



STAMPA
VINTAGE
LAVILLE
SU POLY
COTTON

LAVILLE PARIS





**AB 0477
BORSONE**

In cotone dèlavè ed ecopelle, finiture in metallo canna di fucile, tracolla e manici in ecopelle, tasca interna con chiusura a zip, ricamo vintage del marchio LAVILLE PARIS.

-  **Cotone / Ecopelle**
-  **41 x 41 x 22 cm**
-  **1**
-  **48,00**

**AB 0478
BEAUTY**

Beauty in cotone dèlavè ed ecopelle, manico in ecopelle, ricamo vintage del marchio LAVILLE PARIS.

-  **Cotone / Ecopelle**
-  **27 x 21 x 9 cm**
-  **1**
-  **14,00**

**AB 0484
TRACOLLA**

Tracolla in cotone delavè, unico scomparto con chiusura a zip, tasca frontale aperta, tasca porta documenti sul retro con chiusura a zip, tracolla in ecopelle regolabile. Ricamo marchio LAVILLE Paris vintage.





-  **Cotone / Ecopelle**
-  **24 x 24 x 6 cm**
-  **1**
-  **22,00**



Christian Lacroix



**AB 0854
BEAUTY**

Beauty realizzato in poliuretano e nylon ,
chiusura con zip.

-  Poliuretano e Nylon
-  27 x 15 x 11 cm
-  1
-  **36,00**

**AB 0853
ZAINO ELEMENT**

Super leggero realizzato in morbido poliuretano
nero opaco e in nylon blu scuro molto liscio e
delicato. Custodia interna portcomputer e tasca
con zip sul retro. L'etichetta in gomma stampata
con il logo Christian Lacroix delicatamente
cucito sul nylon dà un tocco giovane e casual.

-  Poliuretano e Nylon
-  27 x 15 x 11 cm
-  1
-  **66,00**

**AB 0852
BORSA DA VIAGGIO
ELEMENT**

Super leggera realizzata in morbido poliuretano
nero opaco e in nylon blu scuro molto liscio e
delicato. L'etichetta in gomma stampata con il
logo Christian Lacroix delicatamente cucito sul
nylon dà un tocco giovane e casual.

-  Poliuretano e Nylon
-  51 x 25 x 28 cm
-  1
-  **98,00**



BORSE & VALIGE

promosolution
2021|2022

HUGO BOSS**AC 1390
TROLLEY CABINA**

Trolley Hugo Boss realizzato in ABS con pattern in stile diamante per un look di stile ed eleganza. Lining interno in alta qualità, doppia tasca interna a rete, chiusura a zip. Chiusura TSA integrata. Confezionato in sacca nylon nera Hugo Boss.

-  ABS
-  Dim: 55 x 36 x 19 cm
Vol: 50 lt
Peso: 3,8 kg
-  1
-  **136,00**



TROLLEY
stile diamante
CHIUSURA TSA
INTEGRATA





new!
SISTEMA
BREVETTATO
DI RUOTA A
SCOMPARSA



1 Tira la leva rossa e apri lo sportellino



2 Estrai la ruota fino al "clac"



3 Chiudi lo sportellino



4 Parti con più spazio in cabina!

AC 1394 TROLLEY CABINA

Trolley in abs con struttura light, dotato di 4 ruote doppie ABS girevoli a 360 gradi con sistema brevettato di ruote a scomparsa che consente di recuperare spazio in cabina, zip a doppio cursore, chiusura TSA integrata.



ABS



Dim. 55x40x20 cm
(con ruote interne)

Vol.: 50 lt - Peso: 2,4 kg



1



98,00





TU



TU



TU



BL



BL



BL

AC 1400 TROLLEY GRANDE

In polipropilene con struttura light, dotato di 4 ruote doppie ABS girevoli a 360 gradi, zip a doppio cursore, chiusura TSA integrata.



Polipropilene



Dim: 75x52x29 cm
Vol: 110 lt
Peso: 4,1 kg



1



128,00

AC 1401 TROLLEY MEDIO

In polipropilene con struttura light, dotato di 4 ruote doppie ABS girevoli a 360 gradi, zip a doppio cursore, chiusura TSA integrata.



Polipropilene



Dim: 65x45x25 cm
Vol: 80 lt
Peso: 3,4 kg



1



98,00

AC 1402 TROLLEY CABINA

In polipropilene con struttura light, dotato di 4 ruote doppie ABS girevoli a 360 gradi, zip a doppio cursore, chiusura TSA integrata.



Polipropilene



Dim: 55x37x20 cm
Vol: 40 lt
Peso: 2,1 kg



1



82,00

NE

JAGUAR

NE



NE



BL



BL



BL



AC 1448 TROLLEY GRANDE

In poliestere 600D "two tone" con struttura super light, tsa integrato, 4 ruote girevoli con cuscinetti, chiusura con zip a doppio cursore, due tasche esterne con zip.



Poliestere



Dim: 78x47x30/35 cm
Vol: 105/125 lt
Peso: 3,7 kg



1



79,00

AC 1449 TROLLEY MEDIO

In poliestere 600D "two tone" con struttura super light, tsa integrato, 4 ruote girevoli con cuscinetti, chiusura con zip a doppio cursore, due tasche esterne con zip.



Poliestere



Dim. 68x42x28/32 cm
Vol.: 80/95 lt
Peso: 2,9kg



1



72,00

AC 1450 TROLLEY CABINA

In poliestere 600D "two tone" con struttura super light, tsa integrato, 4 ruote girevoli con cuscinetti, chiusura con zip a doppio cursore, due tasche esterne con zip.



Poliestere



Dim. 53x38x20 cm
Vol.: 40 lt
Peso: 2,3 kg



1



64,00



AC 1416 TROLLEY

In ABS con struttura super light, 4 ruote girevoli con cuscinetti.

 ABS

 Dim: 68x42x27 cm
Vol: 80 lt
Peso: 3,5 kg

 1

 86,00



 **Saxoline®**

AC 1398 TROLLEY CABINA

In abs con struttura light, dotato di 4 ruote doppie ABS girevoli a 360 gradi, zip a doppio cursore, chiusura TSA integrata.

 ABS

 Dim: 55x38x20 cm
(con ruote interne)
Vol: 40 lt
Peso: 2,6 kg

 1

 76,00

JAGUAR



AC 1406 TROLLEY MEDIO

in poliestere espandibile con interno foderato,
dotato di 4 ruote ABS girevoli a 360 gradi, zip
a doppio cursore, chiusura TSA integrata.

 Poliestere

 Dim: 68x42x28/32 cm
Vol: 80/95 lt
Peso: 2,9 kg

 1

 **78,00**

AC 1407 TROLLEY CABINA

in poliestere espandibile con interno foderato,
dotato di 4 ruote ABS girevoli a 360 gradi, zip
a doppio cursore, chiusura TSA integrata.

 Poliestere

 Dim: 53x38x20 cm
Vol: 40 lt
Peso: 2,3 kg

 1

 **62,00**



**AC 1432
TROLLEY CABINA PORTA
COMPUTER E ABITI 48 ORE**

In poliestere 1680 D, impermeabile e antistrappo, con struttura super light, 2 ruote con cuscinetti a sfera, chiusura con zip a doppio cursore, tascone esterno richiudibile con zip.

-  Poliestere
-  Dim: 38x50x20 cm
Vol: 40 lt
Peso: 2,3 kg

 1

 86,00



**AC 1431
ZAINO TROLLEY
CABINA**

In poliestere, con struttura super light, 2 ruote, chiusura con zip a doppio cursore, spallacci imbottiti a scomparsa, tascone esterno richiudibile con zip.

-  Poliestere
-  Dim: 55x36x21 cm
Vol: 44 lt
Peso: 2,5 Kg

 1

 88,00









CERRUTI 1881



AC 1482 ZAINO PORTA COMPUTER E TABLET

In poliestere "two tone", tasca frontale organizzata, spallacci regolabili.

-  Poliestere 600D
-  24x29x8 cm
-  1
-  **84,00**



AC 1483 ZAINO TROLLEY CABINA





In poliestere, con struttura super light, 2 ruote, chiusura con zip a doppio cursore, dotato di porta usb esterna con cavo interno, spallacci imbottiti a scomparsa, tascone esterno richiudibile con zip.

-  Poliestere
-  50x35x27 cm
-  1
-  **118,00**



AC 1451 BORSA DA VIAGGIO CON TROLLEY

In poliestere 600D "two tone" con struttura super light, 2 ruote, chiusura con zip a doppio cursore, due tasche esterne con zip, tracolla rimovibile e asportabile.

-  Poliestere 600D
-  1
-  Dim: 65x38x35 cm
-  € 74,00
-  Vol: 80 lt - Peso: 2,0 kg

JAGUAR



AC 1481 ZAINO PORTA COMPUTER E TABLET

In poliestere "two tone". Cerniere lampo impermeabili, tasca frontale organizzata, spallacci regolabili.

-  Poliestere 600D
-  1
-  24x29x8 cm
-  € 86,00

JAGUAR



AC 1492 MARSUPIO

In poliestere 600D "two tone", chiusura con zip a doppio cursore, tre tasche esterne con zip, cinghia regolabile.





-  Poliestere 600D
-  20/33 x 13 x 18 cm
-  1
-  € 32,00

JAGUAR



AC 1493 TRACOLLA PORTATABLET

In poliestere 600D "two tone", chiusura con zip, tasca esterna con zip, tracolla regolabile.

-  Poliestere 600D
-  22 x 20 x 7 cm
-  1
-  € 28,00

JAGUAR





AGENDE

promosolution
2021|2022

AGENDA IN PELLE

TASCHE INTERNE

MA



CHIUSURA CON BOTTONE



interno removibile

NE



AD 1524 AGENDA IN PELLE

Agenda portafoglio in pelle fiore con interno giornaliero intercambiabile in carta avorio **sabato e domenica separati**. Chiusura con linguetta e bottone, tasche interne portacard. Corredata di astuccio.



Pelle



17x24 cm



1/10



99,60



AGENDA PORTAFOGLIO IN PELLE



AR

*chiusura con
bottone
magnetico*



MA



BL



INTERNO
GIORNALIERO
INTERCAMBIABILE
CON TASCHE

AD 1520 AGENDA IN PELLE

Agenda portafoglio in pelle fiore con interno giornaliero intercambiabile in carta avorio **sabato e domenica separati**. Chiusura con linguetta e bottone, tasche interne portacard. Corredata di astuccio.



Pelle



17x24 cm



1/10



99,60



AGENDA PORTAFOGLIO

BL



chiusura con bottone



INTERNO
GIORNALIERO
INTERCAMBIABILE
CON TASCHE

NE



AD 1523 AGENDA

Agenda portafoglio in coagulato termovirante con interno giornaliero intercambiabile in carta avorio **sabato e domenica** separati rivestito in vivella. Chiusura con linguetta e bottone, tasche interne portacard. Corredata di astuccio.

i Coagulato

o 17x24 cm

o 1/10

€ 47,52



AGENDA PORTAFOGLIO



*chiusura
con bottone*



AD 1526 AGENDA

Agenda portafoglio in coagulato termovirante con interno giornaliero intercambiabile in carta avorio **sabato e domenica separati** rivestito in vivella. Chiusura con linguetta e bottone. Corredata di astuccio.

 Coagulato

 15x21 cm

 1/10

 44,55



AGENDA BORSELLO



*chiusura
con zip*



AD 1527 AGENDA BORSELLO

Agenda Borsello in coagulato termovirante con interno giornaliero intercambiabile in carta avorio **sabato e domenica separati** rivestito in vivella. Chiusura con zip, tasche interne portacard. Corredata di astuccio.

 Coagulato

 17x24 cm

 1/20

 69,90





AGENDA PORTAFOGLIO INTERNO INTERCAMBIABILE

AD 1528 AGENDA

Agenda portafoglio in coagulato termovirante con interno giornaliero intercambiabile in carta avorio **sabato e domenica separati** rivestito in vivella. Chiusura con linguetta e bottone, tasche interne portacard. Corredata di astuccio.

-  Coagulato
-  17x24 cm
-  1/20
-  **44,40**



TASCHE PORTACARD



AD 1530 AGENDA BORSELLO

Agenda borsello coagulato termovirante con interno giornaliero intercambiabile in carta avorio **sabato e domenica separati** rivestito in vivella. Chiusura con zip, tasche interne portacard. Corredata di astuccio.

-  Coagulato
-  17 x 24 cm
-  1/20
-  **66,00**



AGENDA BORSELLO INTERNO INTERCAMBIABILE





AD 1531 AGENDA

Agenda portafoglio in coagulato termovirante con interno giornaliero intercambiabile in carta avorio **sabato e domenica separati** rivestito in vivella. Chiusura con linguetta e bottone, tasche interne portacard. Corredata di astuccio.

-  Coagulato
-  17x24 cm
-  1/20
-  **50,40**



CHIUSURA
CON
BOTTONE
CARTA
AVORIO

AGENDA
PORTAFOGLIO

AD 1532 AGENDA

Agenda portafoglio coagulato termovirante con interno giornaliero intercambiabile in carta avorio **sabato e domenica separati** rivestito in vivella. Chiusura con linguetta e bottone, tasche interne portacard. Corredata di astuccio.

-  Coagulato
-  15x21 cm
-  1/20
-  **41,40**



BL



AGENDA PORTAFOGLIO

SABATO E DOMENICA SEPARATI
CARTA AVORIO

TO



AD 1533 AGENDA

Agenda portafoglio in coagulato termovirante con interno giornaliero intercambiabile in carta avorio **sabato e domenica separati**.

Chiusura con linguetta e bottone. Corredata di astuccio.



Coagulato



15x21 cm



1/20



29,94



AGENDA JAGUAR portafoglio



RO

LINGUETTA
CHIUSURA
PORTAPENNA



BL



GR



RY

interno removibile



AD 1601 AGENDA GIORNALIERA

Agenda giornaliera a portafoglio con copertina in materiale vivella termovirante bicolore, linguetta di chiusura con bottone con taglio portapenna (penna esclusa), interno mobile giornaliero **sabato e domenica separati** in carta bianca. Astuccio incluso.



Vivella Termovirante



15x21 cm



1/20



12,90



AGENDA JAGUAR

Borsello

INTERNO REMOVIBILE
SABATO E DOMENICA
SEPARATI

confezione in astuccio

CHIUSURA CON ZIP

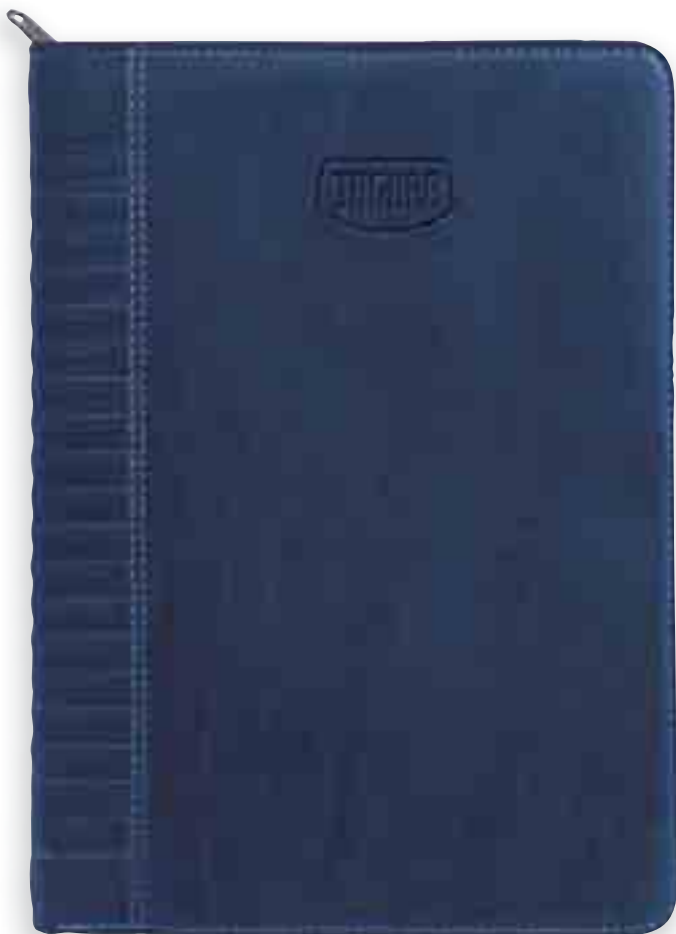

BL

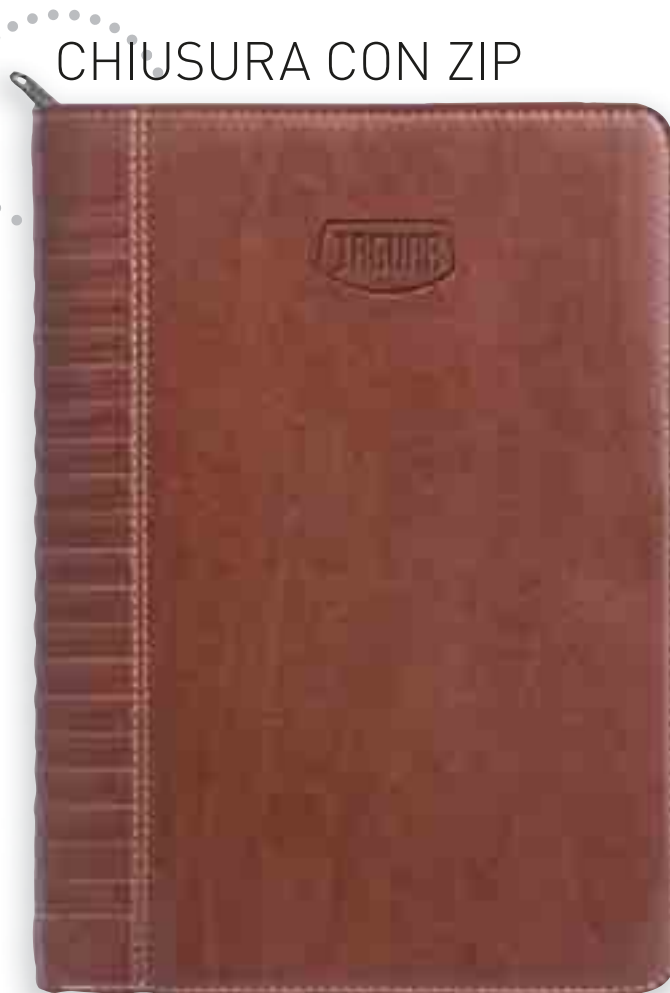

MA



AD 1545
AGENDA BORSELLO

Agenda giornaliera a borsello con copertina in materiale toscana termovirante. Chiusura con zip. Interno mobile, **sabato e domenica separati** in carta avorio da 448 pagine di cui 52 pagine di riepilogo settimanale. Rubrica estraibile. Confezione in astuccio.



Toscana Termovirante



17x24 cm



1/30



71,71



AGENDA JAGUAR **Borsello**

INTERNO REMOVIBILE
SABATO E DOMENICA
 SEPARATI

BL



LINGUETTA CHIUSURA
 CON PORTAPENNA



confezione in astuccio



NE



AR

AD 1600 AGENDA GIORNALIERA

Agenda giornaliera a portafoglio con copertina in materiale vivella Termovirante, linguetta di chiusura con bottone con taglio portapenna, interno mobile giornaliero **sabato e domenica separati** in carta avorio. Astuccio incluso.



Vivella Termovirante



15x21 cm



1/10



14,82



JAGUAR

AGENDA JAGUAR

in morbida Vivella Termovirante

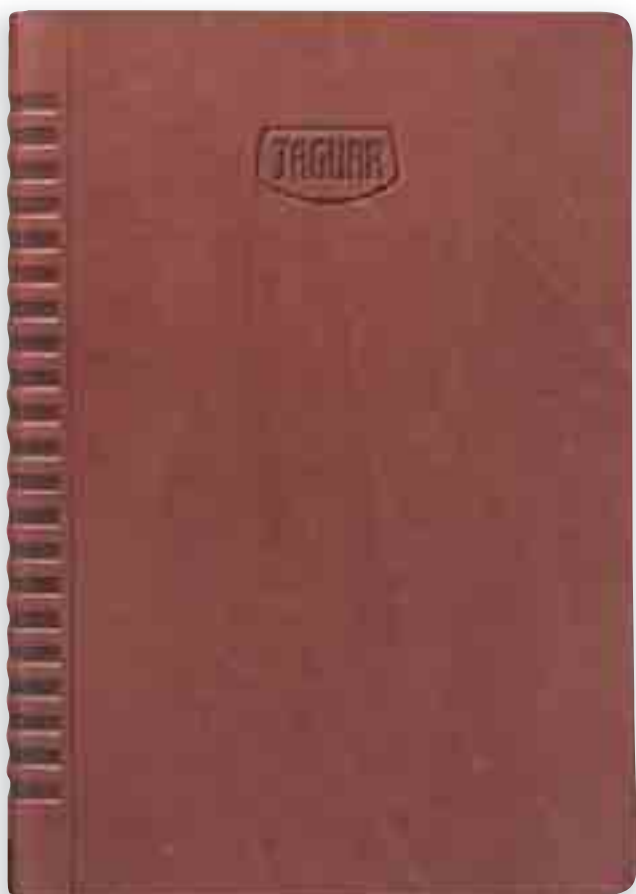

MA

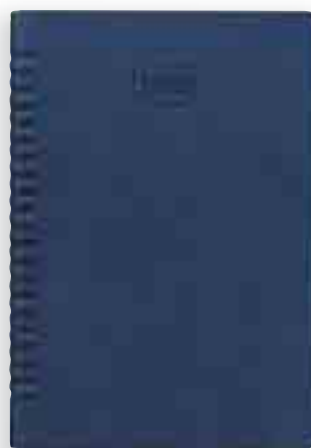

BL

AGENDA
FLESSIBILE
SABATO E
DOMENICA
SEPARATI



confezione in astuccio



AD 1540 AGENDA GIORNALIERA

Agenda giornaliera a blocco fisso in bimatereale toscana abbinato a vivella termovirante. Interno in carta bianca **sabato e domenica separati** da 448 pagine compreso rubrica estraibile e 52 pagine di riepilogo settimanale. Confezione in astuccio.



Vivella Termovirante



17 x 24 cm



1/24



15,84



AGENDA JAGUAR

in Vivella Termovirante



CHIUSURA
CON ELASTICO



SABATO E
DOMENICA
SEPARATI
A BLOCCO
FISSO



confezione in astuccio

AD 1605 AGENDA GIORNALIERA CON ELASTICO

Agenda giornaliera a blocco fisso in bimateriale toscana abbinato a vivella termovirante. Chiusura con elastico. Passante esterno portapenna (penna esclusa). Interno in carta bianca **sabato e domenica separati**. Confezione in astuccio.



Vivella Termovirante



15x21 cm



1/18



14,85



JAGUAR

AGENDA JAGUAR in vivella termovirante

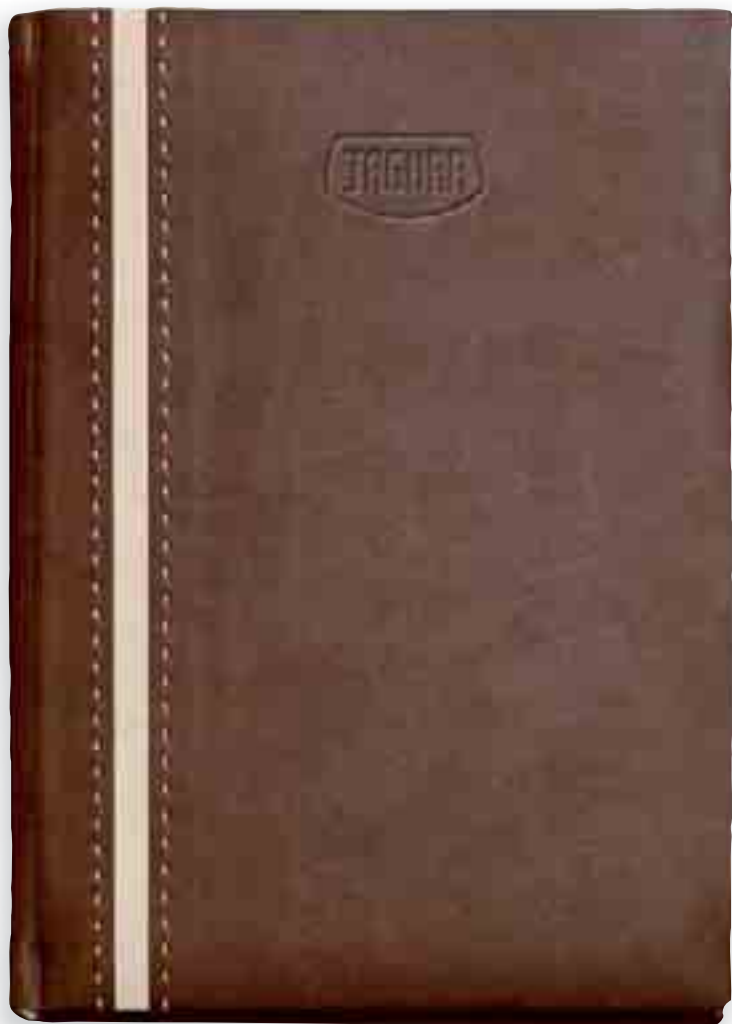

RUBRICA ESTRAIBILE
SABATO E DOMENICA
SEPARATI



AD 1534 AGENDA GIORNALIERA

Agenda giornaliera a blocco fisso in vivella termovirante marrone e beige. Interno **sabato e domenica separati** carta bianca da 448 pagine compresa rubrica fustellata estraibile e 52 pagine di riepilogo settimanale. Confezione in astuccio.

-  Vivella Termovirante
-  17 x 24 cm
-  1/18
-  **16,27**



AGENDA JAGUAR

in vivella termovirante

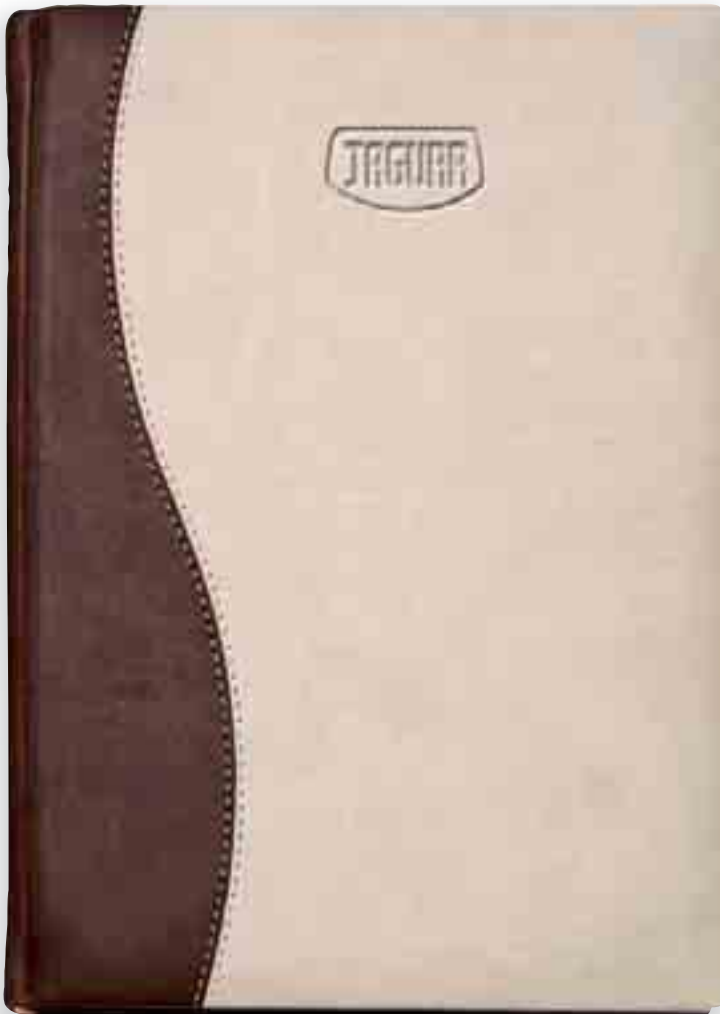

RUBRICA ESTRAIBILE
SABATO E DOMENICA
SEPARATI



AD 1535 AGENDA GIORNALIERA

Agenda giornaliera a blocco fisso in vivella termovirante marrone e beige. Interno **sabato e domenica separati** carta bianca da 448 pagine compresa rubrica fustellata estraibile e 52 pagine di riepilogo settimanale. Confezione in astuccio.

 Vivella Termovirante

 17 x 24 cm

 1/18

 16,27



AGENDA JAGUAR



COPERTINA IN VIVELLA PER STAMPA A CALDO

AD 1625 AGENDA GIORNALIERA

Copertina in Vivella adatta per la stampa a caldo.
Interno Multilingue carta bianca, **sabato e domenica
separati**. Rubrica telefonica, cartina geografica.

-  Vivella Termovirante
-  15 x 21 cm
-  1/20
-  **6,56**



AD 1633 ASTUCCIO

Astuccio In Cartoncino

-  Cartoncino
-  15 x 21 cm
-  **0,36**





RO



RY



MA



BL

DIS
PONI
BILE

in 6 colori



BG



VE

AD 1625
AGENDA GIORNALIERA
Copertina in Vivella adatta per la stampa a caldo.
Interno Multilingue carta bianca, **sabato e domenica**
separati. Rubrica telefonica, cartina geografica.



Vivella Termovirante



15 x 21 cm



1/20



6,56



AGENDA BORSELLO

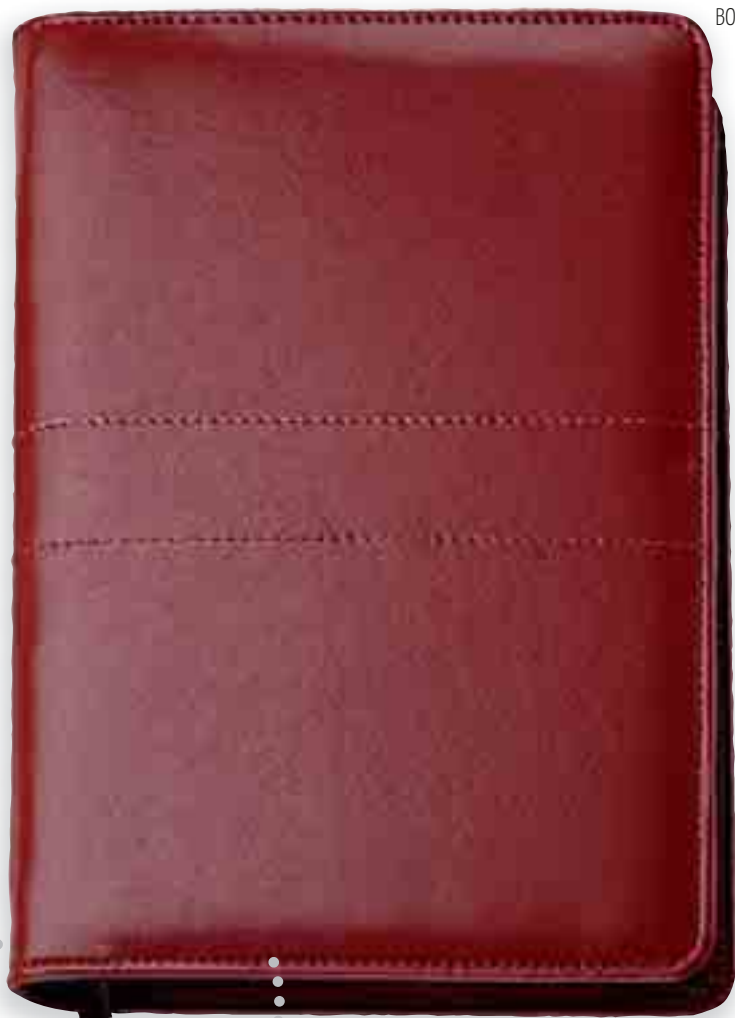

B0

CHIUSURA CON ZIP



INTERNO
REMOVIBILE
GIORNALIERO



NE



BL

**AD 1590
AGENDA**

Agenda borsello in coagulato termovirante, chiusura con zip, tasca interna porta documenti richiudibile con bottone con vari scomparti porta carte di credito. Interno mobile giornaliero in carta bianca **sabato e domenica separati**. Confezione in astuccio.



Coagulato Termovirante



17 x 24 cm



1/30



25,46



AGENDA Borsello



BO

agenda
giornaliera
removibile



IN COAGULATO TERMOVIRANTE



CHIUSURA CON ZIP



NE



BL

AD 1591 AGENDA BORSELLO

Agenda borsello in coagulato termovirante. Chiusura con zip, tasche porta documenti interne, portapenna. Interno giornaliero 15x21 estraibile in carta bianca **sabato e domenica separati**. Confezione in astuccio.



Coagulato Termovirante



15 x 21 cm



1/30



19,35





BO

AGENDA PORTAFOGLIO CON TASCHE INTERNE

CHIUSURA CON
BOTTONE



BL



interno removibile



AD 1551 AGENDA

Agenda portafoglio in coagulato termovirante, chiusura con linguetta e bottone, vari scomparti interni porta carte di credito. Interno mobile giornaliero in carta bianca **sabato e domenica separati**. Confezione in astuccio.



Coagulato Termovirante



17 x 24 cm



1/30



16,91



AGENDA GIORNALIERA

PORTAPENNE
SUL DORSO



TO



NE

| interno removibile |

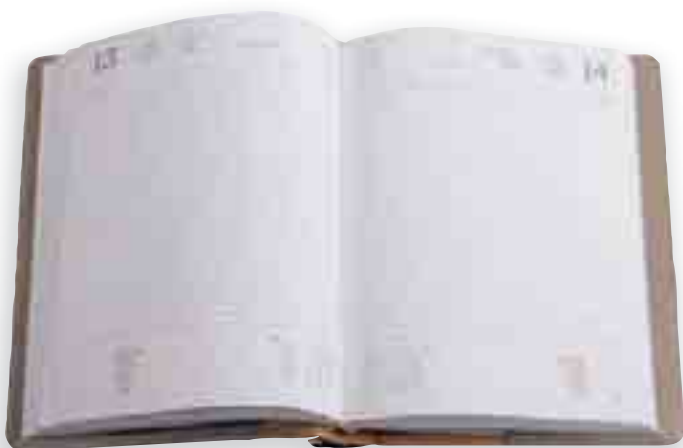

AD 1581 AGENDA

Agenda in coagulato termovirante con vano portapenna sul dorso (penna non inclusa). Interno mobile giornaliero in carta bianca **sabato e domenica separati**. Confezione in astuccio.



Coagulato Termovirante



15x 21 cm



1/30



13,80



AGENDA PORTAFOGLIO

AR



interno removibile



TO



GI



RO

PATTINA ESTERNA CON SCOMPARTI

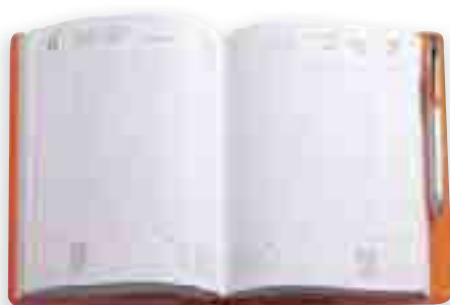

AD 1583 AGENDA

Agenda portafoglio in coagulato termovirante, pattina esterna con chiusura a bottoni e tasca con zip, vari scomparti interni porta carte di credito e porta documenti. Interno mobile giornaliero in carta bianca **sabato e domenica separati**. Confezione in astuccio.



Coagulato Termovirante



15 x 21 cm



1/30



13,50



AGENDA GIORNALIERA CON ELASTICO PORTAPENNE



AGENDA GIORNALIERA CHIUSURA CON BOTTONE



INTERNI
REMOVIBILI
SABATO E
DOMENICA
SEPARATI

AD 1582 AGENDA

Agenda in coagulato termovirante con elastico di chiusura dotato di vano portapenna (penna non inclusa). Interno mobile giornaliero in carta bianca **sabato e domenica separati**. Confezione in astuccio.

 Coagulato Termovirante



 15x 21 cm

 1/30

 **11,70**

AD 1598 AGENDA

Agenda in coagulato termovirante, chiusura con linguetta e bottone. Interno mobile giornaliero in carta bianca **sabato e domenica separati**. Confezione in astuccio.

 Coagulato Termovirante



 15x 21 cm

 1/30

 **17,85**

AGENDA IN PU TERMOMIRANTE

VE



NE



BI



AR



RO



BL



TASCHE ESTERNE
PER CELLULARE,
CARD E PENNA

interno estraibile



AD 1580 AGENDA

Agenda in PU termovirante. Tasche esterne porta cellulare, portacard, portapoggetti, portapenna. Interno giornaliero 15x21 estraibile in carta bianca **sabato e domenica abbinati**. Confezione in astuccio.

-  PU Termovirante
-  16 x 22 cm
-  1/30
-  **11,10**



AGENDA IN **PU** TERMOMOVIANTE



DORSO
PORTA
PENNE



BL



NE

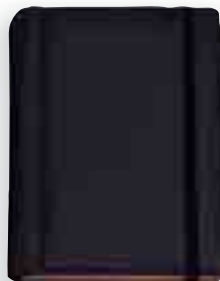

GR



MA



RO



AR



*interno
estraiibile*

AD 1569 AGENDA

Agenda in PU termomovante. Chiusura con elastico, vano esterno portapenne sul dorso. Interno giornaliero 15x21 estraibile in carta bianca **sabato e domenica abbinati**. Confezione in astuccio.



PU Termomovante



15 x 21 cm



1/30



9,60







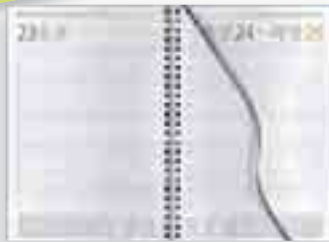

RO

interno giornaliero
**AD 1615
AGENDA GIORNALIERA
15X21**

Con copertina in PVC con spirale. Interno in carta bianca usomano sabato e domenica abbinati 336 pagine.

-  PVC
-  15 x 21 cm
-  1/20
-  **5,70**



BL

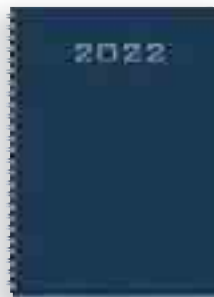

SI



NE







AGENDE IN **PVC** CON SPIRALE

BL

*interno settimanale*
**AD 1616
AGENDA SETTIMANALE
17X24**

Con copertina in PVC con spirale. Interno in carta bianca usomano sabato e domenica abbinati 128 pagine.

-  PVC
-  17 x 24 cm
-  1/40
-  **5,94**



RO



SI







NE



AD 1617 AGENDINA SETTIMANALE 8X12,5

Con copertina in PVC con spirale. Interno in carta bianca usomano 122 pagine.

-  PVC
-  8,5 x 12,5 cm
-  1/100
-  2,25



interno settimanale

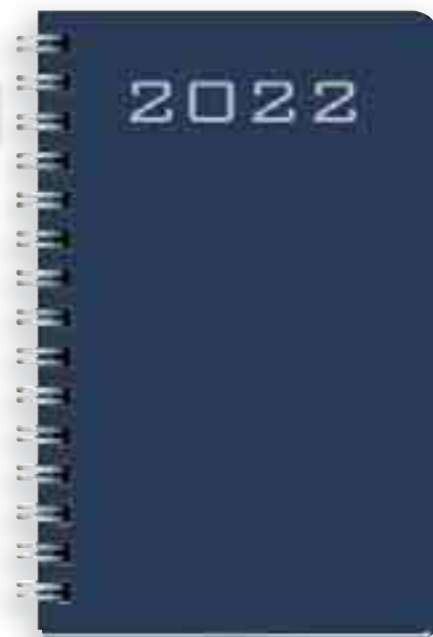

BL

RO



SI







NE



AGENDINA E PLANNING CON SPIRALE

AD 1618 PLANNING SETTIMANALE 29,5X16,5

Con copertina in PVC con spirale. Interno in carta bianca usomano 120 pagine.
Dimensione 29,5X16,5cm.

-  PVC
-  29,5 x 16,5 cm
-  1/50
-  4,77



RO

BL

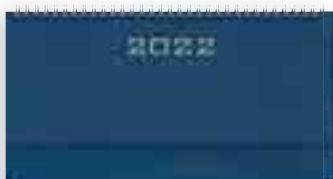

SI

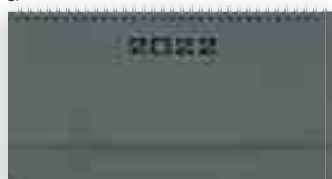

NE

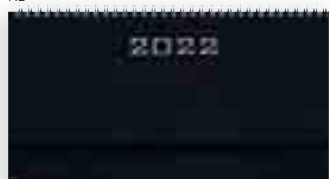

AGENDA

GIORNALIERA

15x21



BI

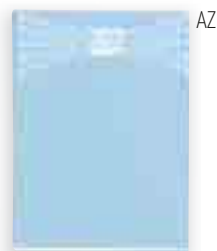

AZ



AR



BO



RO



NE



GR



BL



VE



RY

*con rubrica telefonica
e cartina geografica*



AD 1627

AGENDA GIORNALIERA

15X21

Copertina in matra, interno multilingue da 320 pag. in carta usomano bianca 60 gr sabato e domenica abbinati. Rubrica telefonica e cartina geografica.

 Matra

 15 x 21 cm ca.

 1/20

 **4,41**



AGENDA

GIORNALIERA

11x17



BI

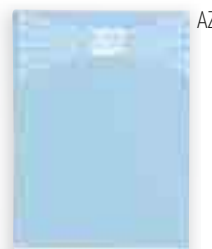

AZ



AR



BO



RO



NE



GR



BL



VE



RY

con rubrica telefonica



AD 1624

AGENDA GIORNALIERA

11X17

Copertina in matra, interno multilingue da 320 pag. in carta usomano bianca 60 gr sabato e domenica abbinati. Rubrica telefonica.



Matra



11 x 17 cm ca.



1/20



4,03



AGENDA

SETTIMANALE

17x24



con rubrica telefonica







AD 1630

AGENDA SETTIMANALE

17x24

Copertina in matra, interno multilingue da 128 pag. in carta usomano bianca 60 gr. Rubrica telefonica.

-  Matra
-  17 x 24 cm ca.
-  1/30
-  **4,41**



AGENDA GIORNALIERA 17x24







con rubrica telefonica



AD 1620 AGENDA GIORNALIERA 17x24

Agenda giornaliera in matra. Interno multilingue, stampa 2 colori, carta bianca, **sabato e domenica abbinati**. Rubrica telefonica, cartina geografica. Festività internazionali.

-  Matra
-  17 x 24 cm ca.
-  1/20
-  4,65



AGENDA MAXI A4 PER RISTORANTI



pagine con perforatura



AD 1613 MAXI AGENDA RISTORANTI A4

Copertina in matra, interno multilingue da 576 pag. in carta usomano bianca 60 gr. **Venerdì sabato e domenica in doppia pagina.** Pagine con foratura parallela al dorso. Rubrica telefonica.



Matra



21 x 29,7 cm ca.



1/14



21,83



AGENDA

GIORNALIERA

MAXI A4

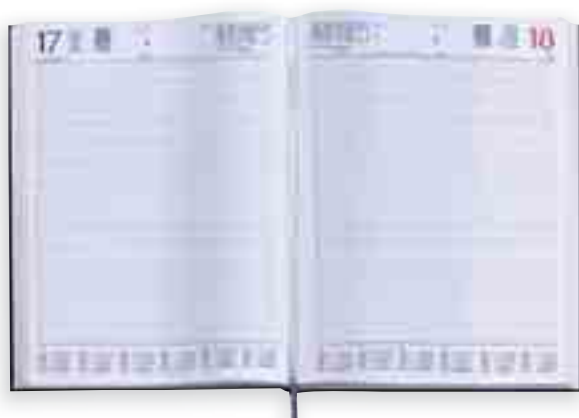





pagine con foratura



AD 1614 MAXI AGENDA GIORNALIERA A4

Copertina in matra, interno multilingue da 384 pag. in carta usomano bianca 60 gr. sabato e domenica separati. Pagine con foratura parallela al dorso. Rubrica telefonica.





-  Matra
-  21 x 29,7 cm ca.
-  1/14
-  **12,80**





AD 1640 AGENDINA SETTIMANALE 8x14

Copertina in matra, interno multilingue da 128 pag. in carta usomano bianca 60 gr. Rubrica telefonica.

-  Matra
-  8 x 14 cm ca.
-  10/100
-  **1,89**



AR

RO

AZ

BO

BI

BL

GR

NE



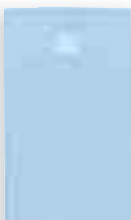

VE

RY



AD 1645 AGENDINA BIGIORNALIERA 7x10

Copertina in matra, interno multilingue da 384 pag. in carta usomano bianca 60 gr. Rubrica telefonica.

-  Matra
-  7 x 10 cm ca.
-  10/100
-  **1,89**



RO

NE

VE

RY

BL

BO



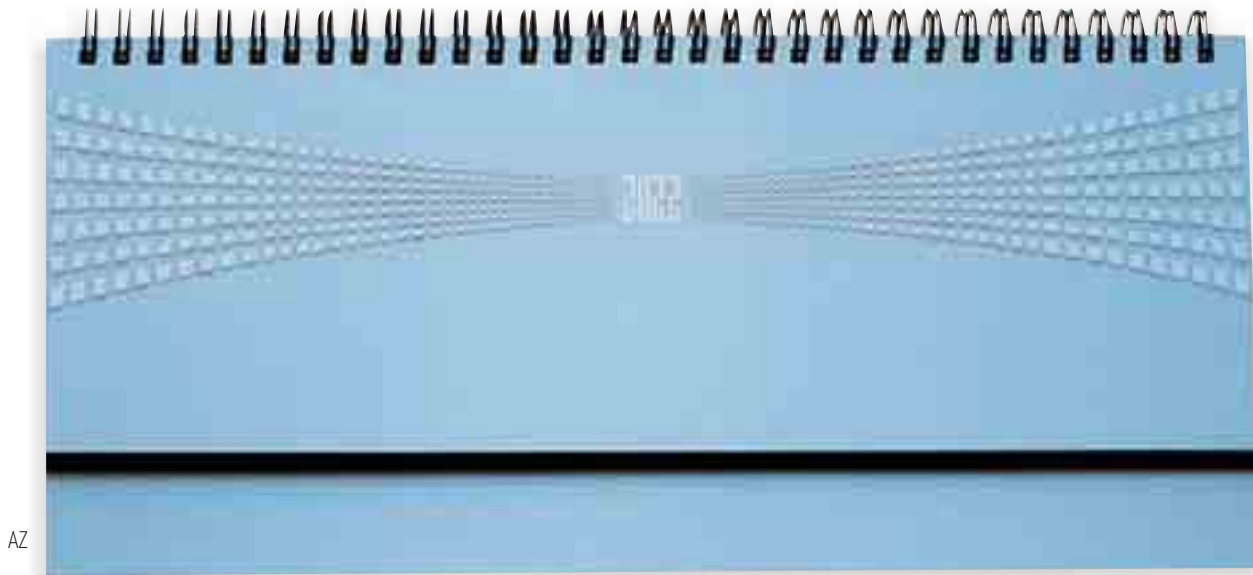



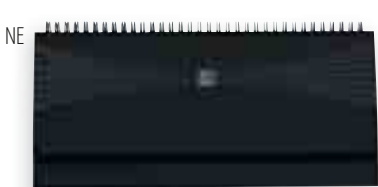
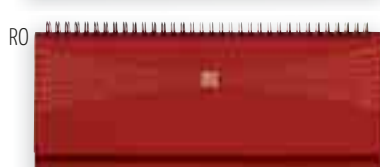
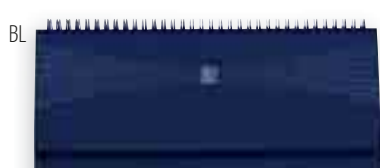
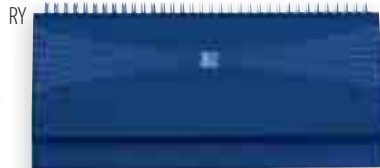

PLANNING SETTIMANALE



AD 1650 PLANNING SETTIMANALE 30X15

Copertina in matra, interno multilingue da 128 pag.
in carta usomano bianca 60 gr. Rubrica telefonica
Dim. 30X15 cm. ca

-  Matra
-  30 x 15 cm ca.
-  1/20
-  **4,51**



con rubrica telefonica



AD 1654 AGENDA GIORNALIERA

Agenda giornaliera in matra. Interno multilingue, stampa 2 colori, carta bianca, sabato e domenica abbinati. Rubrica telefonica, cartina geografica. Festività internazionali.

 Matra

 15 x 21 cm

 1/20

 **4,41**



AD 1657 AGENDINA SETTIMANALE

Agendina settimanale in matra. Interno multilingue, carta bianca. Rubrica telefonica.

 Matra

 8 x 15 cm

 10/100

 **1,89**

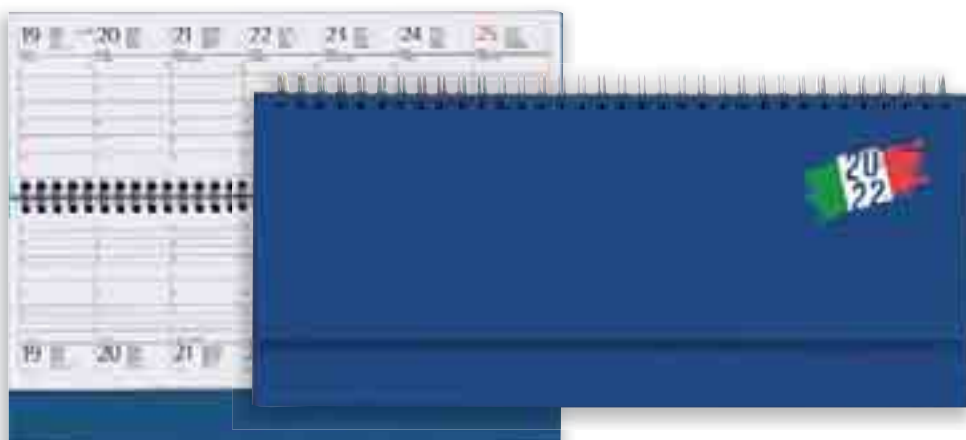

AD 1652 PLANNING

Planning da tavolo in matra con spirale.

 Matra

 30 x 15 cm

 1/20

 **4,51**





MEETING & NOTES

promosolution
2021|2022

ZAINO IN POLIESTERE PER TABLET E COMPUTER







Spallacci regolabili

**SCOMPARTI
IMBOTTITI
CHIUSURE
DOPPIA ZIP**



AF 1655 ZAINO PORTACOMPUTER

Zaino in poliestere con due scomparti con chiusura a doppia zip, scomparto con interno imbottito per tablet e computer portatile 15", scomparto secondario con varie tasche interne, tre tasche esterne frontali con cerniera più due tasche laterali, due spallacci imbottiti e regolabili, in elegante scatola regalo.

-  Poliestere
-  35 x 45 x 18 cm
-  1/10
-  **134,70**

ZAINO IN POLIESTERE PER TABLET E COMPUTER



chiusura doppia zip

**SCOMPARTI
IMBOTTITI**

AF 1664 ZAINO MAGNUM

Zaino in nylon con chiusura a doppia zip, tasca interna imbottita portacomputer, tasca portatablet, varie tasche interne, spallacci rebolabili imbottiti. Tasca laterale con chiusura a zip e tasca antifurto segrata sul retro con cerniera. Porta usb esterna e chiusura TSA integrata. Confezionato in elegante scatola regalo.

-  Nylon
-  47 x 33 x 17 cm
-  1/10
-  **119,70**





ZAINO ANTI FURTO





TASCA PER
COMPUTER 15"

PORTA USB ESTERNA







AF 1659 ZAINO ANTIFURTO

Zaino bicolore semirigido, parte centrale in nylon e parte superiore e inferiore in PVC, ampio scomparto interno, tasca porta computer da 15 pollici, varie tasche interne, porta USB esterna con cavo all'interno, tasca segreta con cerniera sul retro, bretelle imbottite regolabili.

-  Nylon + PVC
-  45 x 35 x 11 cm
-  1/10
-  € 62,40

AF 1663 ZAINO MARTIN

Zaino in poliestere con chiusura a doppia zip, tasca interna imbottita portacomputer, varie tasche interne, spallacci regolabili. Doppia tasca esterna con chiusura a zip. Porta usb esterna.

-  Poliestere
-  42 x 34 x 10 cm
-  1/25
-  **25,50**

ZAINO IN POLIESTERE



GR



**DOPPIA ZIP
DI CHIUSURA**



**DOPPIA
TASCA
ESTERNA
CON
CHIUSURA
ZIP**



**TASCA
INTERNA PER
COMPUTER
IMBOTTITA**

NE







ZAINO IN NYLON PER COMPUTER

Due Tasche



AF 1669 ZAINO PORTACOMPUTER

Zaino in nylon con due scomparti, scomparto principale con interno imbottito per computer portatile, scomparto secondario con varie tasche interne, due tasche esterne frontali con cerniera e due tasche a rete sui lati, due spallacci imbottiti, manico con impugnatura ergonomica .

-  Nylon
-  45 x 30 x 15 cm
-  1/10
-  **38,85**



ZAINO

PORTA
COMPUTER
15 pollici

scomparto principale imbottito



**AF 1665
ZAINO
PORTACOMPUTER**

Zaino portacomputer 15 pollici, scomparto principale con vano imbottito per un portatile, tasche interne, vano sulla parte anteriore con chiusura lampo, manico, spallacci regolabili.

 Poliestere 600D e PVC

 44 x 28,5 x 12 cm

 1/10

 **74,70**



BORSA PORTA COMPUTER

tracolla regolabile

AF 1677 BORSA PORTACOMPUTER

Porta computer primo scomparto con cerniera per portatile e 3 tasche, secondo scomparto con ampia funzione organizer a cerniera, tasca anteriore e sul retro a strappo, maniglia rinforzata a strappo, tracolla regolabile ed asportabile con parte imbottita.

 POLIESTERE 600D

 40 x 30 x 13 cm

 1/20

 28,65



BORSA PORTA DOCUMENTI

TASCA ANTERIORE E LATERALE



RO



AR

AZ

AF 1687 BORSA PORTADOCUMENTI

Portadocumenti bicolore. Chiusura con zip. Tasca laterale portaoggetti. Doppio manico. Tracolla regolabile. Comoda tasca anteriore con zip. Confezione in polybag.

 Poliestere 600D





 38 x 28 x 9,5 cm

 1/40

 7,89

AF 1710 PORTABLOCCO A4

Portablocco in pvc e microfibra con manici a scomparsa. Con calcolatrice e blocco carta da 20 fogli. Tasche interne portadocumenti e portacard.

-  PVC - Microfibra
-  34 x 25,5 x 2,5 cm
-  1/15
-  **39,60**



MANICI A SCOMPARSA





PORTABLOCCHI A4 CON BLOCCO E CALCOLATRICE

CHIUSURA CON ZIP



AF 1718 PORTABLOCCO A4

Portablocco congresso in neopel 2 ante. Chiusura con zip. Varie tasche interne per documenti, uno scomparto interno con cerniera. Una tasca esterna. Completa di blocco e calcolatrice.

-  Neopel
-  34,5 x 26 x 3 cm
-  1/15
-  **22,60**

NE



BL



RO



PORTABLOCCO **A4** RICHIUDIBILE CON ELASTICO

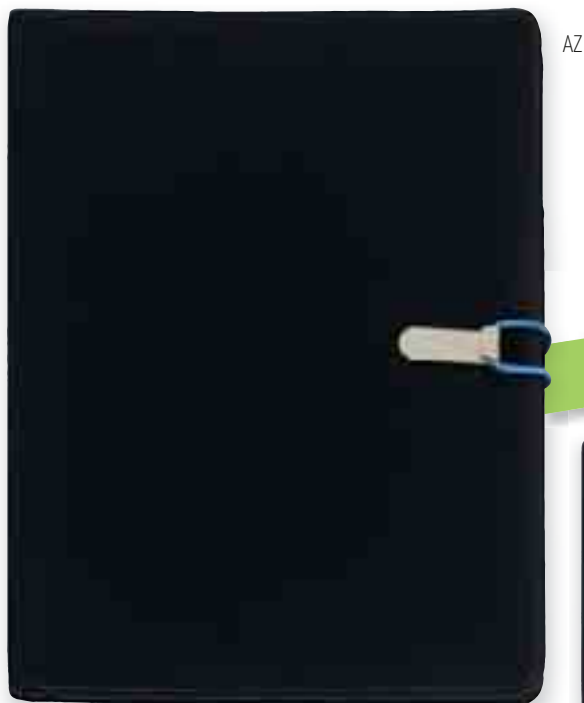





BLOCCO INCLUSO



AF 1715 PORTABLOCCO **A4**

formato A4 richiudibile con elastico colorato, laccetto per penna, diversi scomparti, blocco notes incluso.

-  Poliestere / PU
-  32,5 x 25 x 1 cm
-  1/20
-  **11,37**







INTERNO COLORATO



AF 1712 PORTABLOCCO **A4**

Prendi appunti in formato A4; con blocco colorato, anello per una penna, diverse taschine, all'esterno con laccio elastico a chiusura, interno colorato esterno nero.

-  Poliestere
-  32 x 26 x 2 cm
-  1/20
-  **13,35**

PORTABLOCCO **A4** RICHIUDIBILE CON ELASTICO

TACCUINI CON SPIRALE



BL



SI







BI

FORMATO A6

FORMATO A5

AF 1733 TACCUINO A6





Formato A6, copertina in PP, interno 65 pagine a righe, dotato di penna a sfera in plastica con clip in metallo, refill blu.

-  Polipropilene
-  15 x 13 x 1,3 cm
-  1/30
-  **2,37**

dotati di
penna
a sfera
refil blu

AF 1734 TACCUINO A5

Formato A5, copertina in PP, interno 65 pagine a righe, dotato di penna a sfera in plastica con clip in metallo, refill blu.

-  Polipropilene
-  21 x 17,8 cm
-  1/80
-  **3,87**

CARTELLINA **A4**

BL

CON PINZA PORTABLOCCO







RO

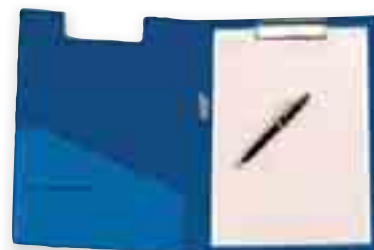

BI

**AF 1725
CARTELLINA A4**

Cartella 2 ante, con pinza portablocco. Confezione in polybag.
(blocco notes e penna non inclusi).

-  PVC
-  22 x 32 cm
-  1/50
-  **2,67**



AZ

CHIUSURA ERMETICA



VE



BI

**AF 1719
BUSTA PORTADOCUMENTI**

Formato A4, chiusura ermetica, in PVC trasparente.

-  PVC
-  23,8 x 32,8 cm
-  1/100
-  **0,63**

BUSTA
PORTADOCUMENTI

BUSTE PORTADOCUMENTI



DISPONIBILI IN DIVERSI COLORI

AR



RO



BL







VE



33,5x24 cm

AF 1720 BUSTA PORTADOCUMENTI

Busta portadocumenti, chiusura con bottone. Confezione in polybag.

-  PVC
-  33,5 x 24 cm
-  20/200
-  **0,54**

24x17 cm

AF 1721 BUSTA PORTADOCUMENTI



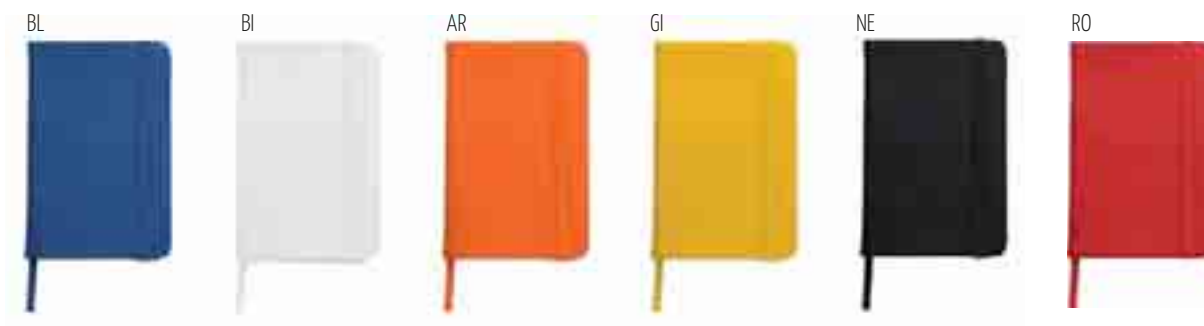

Busta portadocumenti, chiusura con bottone. Confezione in polybag.

-  PVC
-  24 x 17 cm
-  20/300
-  **0,45**



AF 1738 BLOCK NOTES A6





Blocco notes, chiusura con elastico e segnalibro.
In PU colorato.

-  Poliuretano
-  9 x 14 x 1,3 cm
-  25/200
-  **1,95**

chiusura
con
elastico e
segnalibro

AF 1746 BLOCK NOTES A5

Blocco notes, chiusura con elastico e segnalibro.
In PU colorato.





-  Poliuretano
-  14 x 21 x 1,5 cm
-  25/100
-  **3,87**

BLOCK NOTES



AF 1737 BLOCK NOTES A6





Blocco notes bianco, chiusura con elastico, 80 pagine interne a righe, segnalibro.

-  Midi Cartonato
-  14 x 9 x 1,3 cm
-  40/240
-  **2,04**

80 pagine
con righe
e
segnalibro

AF 1750 BLOCK NOTES A5





Blocco notes bianco, chiusura con elastico, 80 pagine interne a righe, segnalibro.

-  Midi Cartonato
-  20,7 x 14,2 x 1,3 cm
-  25/100
-  **4,17**



AF 1735 CARTELLA PORTADOCUMENTI

Include 150 segnapagina adesivi in vari colori, block-notes a righe da 25 pagine, penna a sfera refill blu con fusto e clip in cartone.

-  Cartone 600 gr
-  33,7 x 26 cm
-  1/40
-  **4,17**

BG







CARTELLE PORTA DOCUMENTI

con set memo, penna e blocco



AF 1731 CARTELLA DI SCRITTURA

Cartella da scrittura con blocco interno da 20 fogli formato +/- A4, penna in cartone con refill nero, set memo in 4 colori con 25 fogli per colore, manico integrato.

-  Cartone 600 gr
-  34,5 x 28,9 x 2,3 cm
-  1/25
-  **4,47**

AF 1739 BLOCK NOTES

Da 60 fogli, spiralato "ECO PAPER"
Completo di penna refill blu.
Confezione in astuccio.

 Cartoncino /Metallo

 17,9 x 13,4 x 2 cm

 20/100

 2,37



BLOCK NOTES CON SPIRALE



AF 1748 TACCUINO A5

Incluse 72 fogli a righe rilegati con spirale, in carta minerale.

 Carta Minerale

 18,1 x 14 x 1,1 cm

 20/80

 4,47

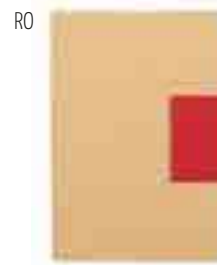
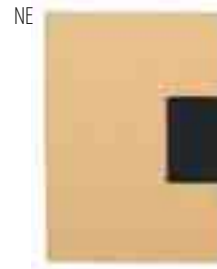

AF 1747
BLOCK NOTES A5

Blocco notes in cartoncino con penna, biodegradabile, chiusura con calamite.

 Cartoncino biodegradabile

 21 x 14,7 x 1,8 cm

 25/100

 **3,45**

*Chiusura
con Calamita*



BLOCK NOTES **BIODEGRADABILI**



*Chiusura
con Elastico*

AF 1743
BLOCK NOTES A6

Blocco notes in cartoncino con penna, biodegradabile, chiusura con elastico.

 Cartoncino biodegradabile

 14 x 9,8 x 0,9 cm

 50/200

 **2,37**





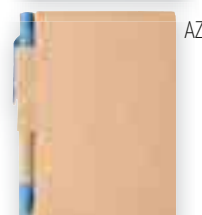
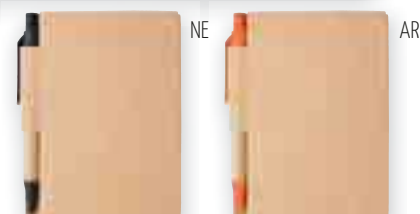
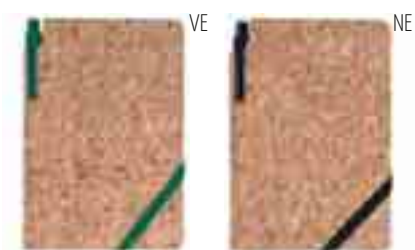

Block Notes

CON PENNA IN
CARTONCINO







AF 1745 BLOCK NOTES A6

Blocco notes in sughero con penna in cartoncino biodegradabile, chiusura con elastico.

-  Sughero
-  10 x 14 x 1,3 cm
-  50/200
-  2,94

AF 1742 BLOCK NOTES

Blocco notes in cartone, 80 fogli a righe, penna a sfera refill nero con fusto in cartone.

-  Cartoncino
-  8,9 x 11,1 cm
-  50/200
-  1,38



IN **ECOPAPER**
con PENNA e POST-IT



AF 1760 MINI QUADERNO

Quaderno in "ECO PAPER" con post-it, penna a sfera refill nero.

-  **ECOPAPER**
-  **10,5 x 8 cm**
-  **100/400**
-  **1,98**





CHIUSURA con ELASTICO
IN **CARTONCINO**
RICICLATO



AF 1763 MEMOBOX

Memo con foglietti adesivi e scomparto per bigliettini da visita, richiudibile con elastico, in materiale riciclato.

-  **Cartoncino riciclato**
-  **10,5 x 6,8 cm**
-  **100/500**
-  **0,99**







100 MEMO IN **VARI** COLORI







AF 1764 SET MEMO

Memo con spirale, 125 memo stick rettangolari in vari colori, 100 memo stick quadrati in vari colori.

-  **Cartone/Metallo**
-  **7,5 x 8 x 2,5**
-  **25/200**
-  **2,07**

**AF 1762
MEMOBOX**

Memo con 120 foglietti, 20 graffette in scomparto nascosto, 100 bandierine segnalibro colorate, penna a sfera mini refill nero, copertina in cartone riciclabile.

-  **Cartone/Plastica**
-  **16,5 x 10,4 x 2,2 cm**
-  **25/100**
-  **4,98**



*Memo con
120 foglietti*





CON GRAFFETTE E MINI PENNA

SET MEMO CON **RIGHELLO 13 CM**

*Penna a sfera
refil blu*

**AF 1759
SET MEMO**

Set Memo Con righello 13 cm integrato, memo stick in 4 formati ed in vari colori, penna a sfera con corpo in cartone, refill blu.





-  **Cartoncino riciclato**
-  **16 x 8 x 1,2 cm**
-  **50/200**
-  **2,25**





AF 1765 SET MEMO CON PENNA

Set memo ECO style da scrivania, supporto in paglia di grano, include 100 fogli autoadesivi, foglie in silicone, penna a sfera in legno refill nero.

-  Paglia di grano/Silicone/Legno
-  11,5 x 6,5 x 2,5 cm
-  10/50
-  4,77

Set da scrivania in ECO

con PENNA e FOGLI ADESIVI

CUBO CARTA USOMANO

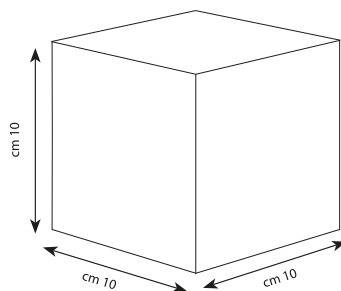

AF 1767 CUBO CARTA

Cubo in carta bianca usomano.

-  Carta
-  9,6 x 9,6 x 9,6 cm
-  24/96
-  6,60

CUBO CARTA PORTA PENNA

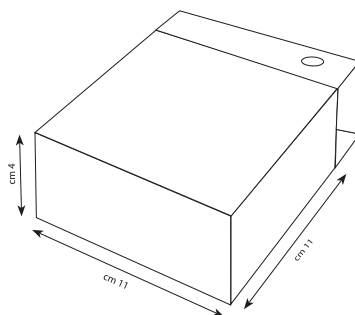

AF 1768 MINI CUBO PORTAPENNA

Cubo in carta bianca usomano con cartoncino portapenna.

-  Carta
-  11,5 x 11,5 x 3,8 cm
-  12/120
-  5,55



CALENDARI

promosolution
2021|2022

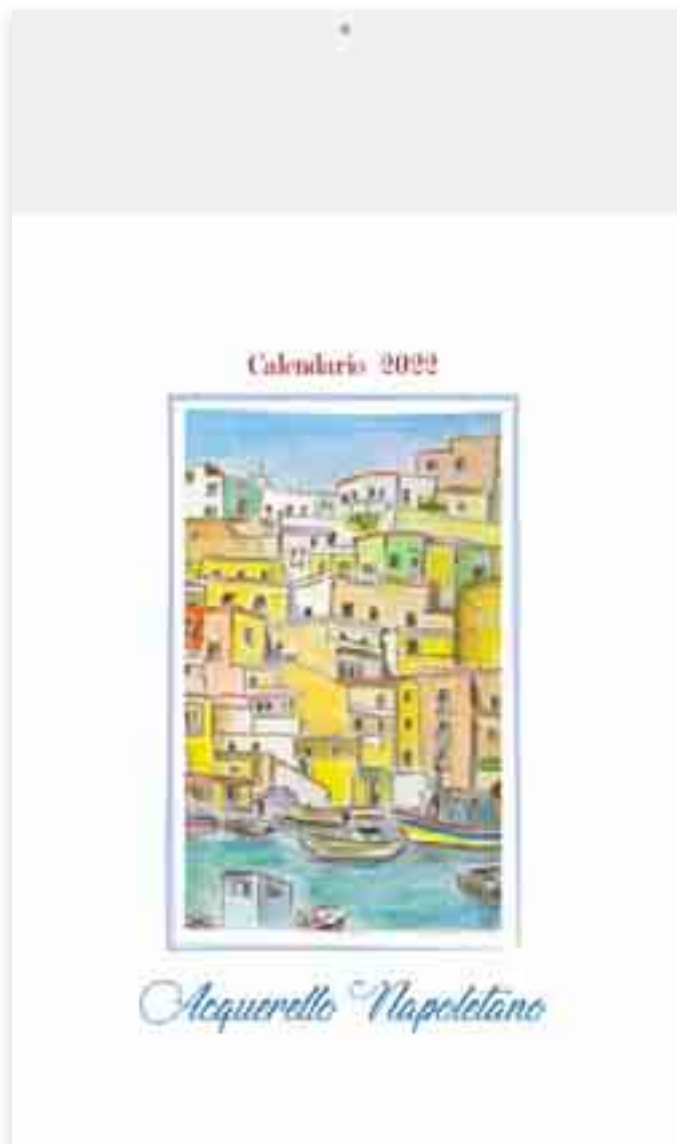

AG 1776
ACQUERELLO
NAPOLETANO

Calendario mensile 13 fogli. Carta patinata opaca stampa 4 colori. Testata rigida rinforzata in triplo cartoncino.

 Carta patinata opaca 90 gr

 Calendario 31 x 53 cm
 Testata 31 x 10,8 cm

 100

 **1,74**



GENNAIO



MAGGIO



SETTEMBRE



FEBBRAIO



GIUGNO



OTTOBRE



MARZO



LUGLIO



NOVEMBRE



APRILE



AGOSTO



DICEMBRE





GENNAIO



APRILE



LUGLIO



OTTOBRE



FEBBRAIO



MAGGIO



AGOSTO



NOVEMBRE



MARZO



GIUGNO



SETTEMBRE



DICEMBRE



AG 1778 ACQUERELLO NAPOLETANO DA TAVOLO

Spiralato 13 fogli carta patinata, planning
2022 e 2023 sul retro.



Carta patinata opaca 100 gr



Calendario 19 x 14,5 cm
Spazio Stampa 19 x 4 cm



100



0,78





AG 2000 PAPA FRANCESCO

Calendario mensile 12 fogli, Carta Patinata
Stampa 4 colori fronte/retro, Festività
Internazionali, Testata Termosaldata.

 Carta patinata 70 gr

 Calendario 28,8 x 47 cm
Testata 28,8 x 9 cm

 100

 1,15



GENNAIO



MAGGIO

FEBBRAIO



GIUGNO

MARZO



LUGLIO

APRILE



AGOSTO



SETTEMBRE



OTTOBRE



NOVEMBRE







DICEMBRE





**AG 1950
CITTA' ITALIANE**

Calendario mensile 12 fogli, Carta Patinata
Stampa 4 colori fronte/retro, Festività
Internazionali, Testata Termosaldata.





-  Carta patinata 70 gr
-  Calendario 28,8 x 47 cm
-  Testata 28,8 x 9 cm
-  100
-  **1,15**





AG 1957 CITTA' DEL MONDO

Calendario mensile 12 fogli, Carta Patinata
Stampa 4 colori fronte/retro, Festività
Internazionali, Testata Termosaldata.

-  Carta patinata 70 gr
-  Calendario 28,8 x 47 cm
Testata 28,8 x 9 cm
-  100
-  1,15



GENNAIO



MAGGIO



SETTEMBRE



FEBBRAIO



GIUGNO



OTTOBRE



MARZO



LUGLIO



NOVEMBRE



APRILE



AGOSTO



DICEMBRE



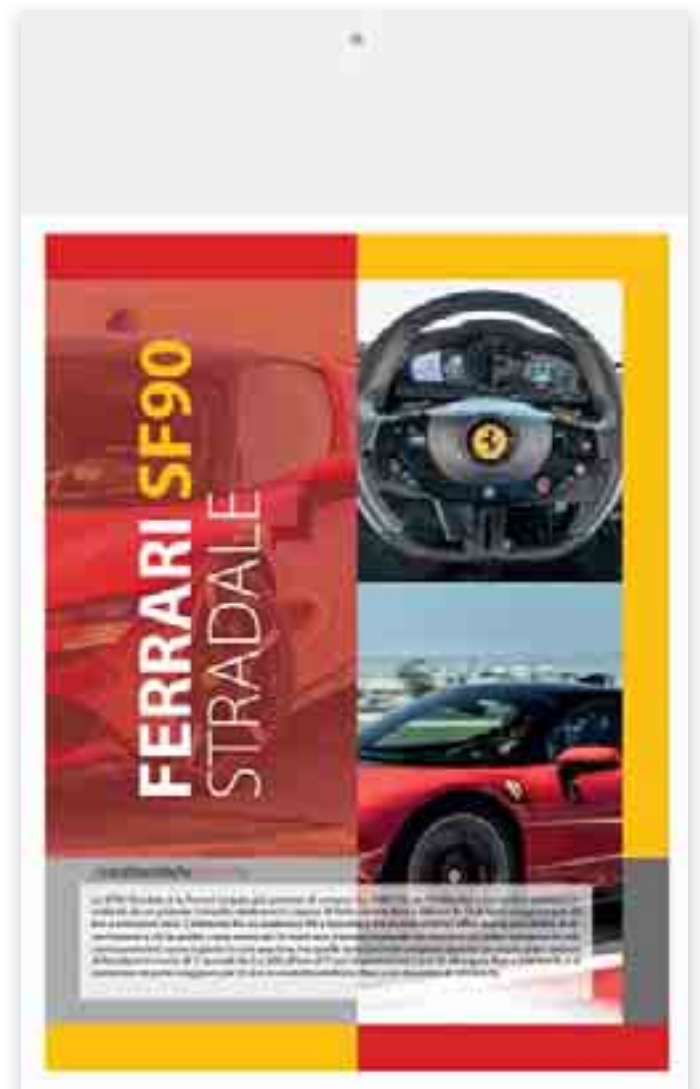



AG 1955 MOTORI

Calendario mensile 12 fogli, Carta Patinata
Stampa 4 colori fronte/retro, Festività
Internazionali, Testata Termosaldata.

 Carta patinata 70 gr

 Calendario 28,8 x 47 cm
Testata 28,8 x 9 cm

 100

 1,15



GENNAIO



FEBBRAIO



MARZO



APRILE



MAGGIO



GIUGNO



LUGLIO



AGOSTO



SETTEMBRE



OTTOBRE



NOVEMBRE



DICEMBRE





AG 1965 HOME DESIGN

Calendario mensile 12 fogli, Carta Patinata
Stampa 4 colori fronte/retro, Festività
Internazionali, Testata Termosaldata.

 Carta patinata 70 gr

 Calendario 28,8 x 47 cm
Testata 28,8 x 9 cm

 100

 1,15



GENNAIO



FEBBRAIO



MARZO



APRILE



MAGGIO



GIUGNO



LUGLIO



AGOSTO



SETTEMBRE



OTTOBRE



NOVEMBRE



DICEMBRE





AG 1963 LUNARIO

Calendario mensile 12 fogli, Carta Patinata
Stampa 4 colori fronte/retro, Festività
Internazionali, Testata Termosaldata.

 Carta patinata 70 gr

 Calendario 28,8 x 47 cm
Testata 28,8 x 9 cm

 100

 1,15



GENNAIO



FEBBRAIO



MARZO



APRILE



MAGGIO



GIUGNO



LUGLIO



AGOSTO



SETTEMBRE



OTTOBRE



NOVEMBRE



DICEMBRE





**AG 1966
ASTROLOGIA**

Calendario mensile 12 fogli, Carta Patinata
Stampa 4 colori fronte/retro, Festività
Internazionali, Testata Termosaldata.



Carta patinata 70 gr



Calendario 28,8 x 47 cm
Testata 28,8 x 9 cm



100



1,15



GENNAIO

FEBBRAIO

MARZO

APRILE

MAGGIO

GIUGNO



LUGLIO

AGOSTO

SETTEMBRE

OTTOBRE

NOVEMBRE

DICEMBRE





AG 1962 LUNARIO

Calendario mensile 12 fogli, Carta Patinata
Stampa 4 colori fronte/retro, Festività
Internazionali, Testata Termosaldata.



Carta patinata 70 gr



Calendario 28,8 x 47 cm
Testata 28,8 x 9 cm



100



1,15



GENNAIO



LUGLIO



FEBBRAIO



AGOSTO



MARZO



SETTEMBRE



APRILE



OTTOBRE



MAGGIO



NOVEMBRE



GIUGNO







DICEMBRE





**AG 2025
4 STAGIONI**

Calendario mensile 12 fogli, Carta Patinata
Stampa 4 colori fronte/retro, Festività
Internazionali, Testata Termosaldata.

-  Carta patinata 70 gr
-  Calendario 28,8 x 47 cm
Testata 28,8 x 9 cm
-  100
-  1,15





AG 2022 FARMACIA

Calendario mensile 12 fogli, Carta Patinata Stampa 4 colori fronte/retro, Festività Internazionali, Testata Termosaldata.

- Carta patinata 70 gr
- Calendario 28,8 x 47 cm
Testata 28,8 x 9 cm
- 100
- 1,15





RETRO DA COLORARE

GENNAIO



FEBBRAIO



MARZO



APRILE



MAGGIO



GIUGNO



LUGLIO



AGOSTO



SETTEMBRE



OTTOBRE



NOVEMBRE

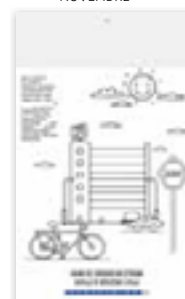

DICEMBRE



AG 2002 RAGAZZI DA COLORARE

Calendario mensile 12 fogli da colorare,
carta patinata stampa 4 colori fronte/retro,
Festività internazionali. Testata termosaldata.

 Carta patinata 70 gr

 Calendario 28,8 x 47 cm
Testata 28,8 x 9 cm

 100

 1,15





GENNAIO 2022	
1	VEN
2	SAB
3	LUN
4	MAR
5	MEI
6	JUN
7	VEN
8	SAB
9	SAB
10	LUN
11	MAR
12	MEI
13	JUN
14	VEN
15	SAB
16	SAB
17	LUN
18	MAR
19	MEI
20	JUN
21	VEN
22	SAB
23	SAB
24	LUN
25	MAR
26	MEI
27	JUN
28	VEN
29	SAB
30	SAB
31	LUN

Barboncino Toy

Il Barboncino Toy o Boodle Toy è una delle razze di barboncini con caratteristiche peculiari di un cane di compagnia. Questo cane che misura 30 centimetri massimo alla spalla, è dolce e amichevole. Il Barboncino Toy è un cane di compagnia che si adatta a tutti gli stili di vita e a tutti i tipi di appartamenti. È un cane di compagnia che si adatta a tutti i tipi di appartamenti. È un cane di compagnia che si adatta a tutti i tipi di appartamenti.

Caratteristiche del Barboncino Toy

Il Barboncino Toy è un cane di compagnia che si adatta a tutti i tipi di appartamenti. È un cane di compagnia che si adatta a tutti i tipi di appartamenti. È un cane di compagnia che si adatta a tutti i tipi di appartamenti.



Barboncino Toy

Caratteristiche del Barboncino Toy

Il Barboncino Toy è un cane di compagnia che si adatta a tutti i tipi di appartamenti. È un cane di compagnia che si adatta a tutti i tipi di appartamenti. È un cane di compagnia che si adatta a tutti i tipi di appartamenti.

AG 2021 CUCCIOLI

Calendario mensile 12 fogli, Carta Patinata
Stampa 4 colori fronte/retro, Festività
Internazionali, Testata Termosaldata.



Carta patinata 70 gr



Calendario 28,8 x 47 cm
Testata 28,8 x 9 cm



100



1,15



GENNAIO



MAGGIO



SETTEMBRE



FEBBRAIO



GIUGNO



OTTOBRE



MARZO



LUGLIO



NOVEMBRE



APRILE



AGOSTO



DICEMBRE





GENNAIO 2022	
1	VEN
2	SAB
3	SAB
4	SAB
5	SAB
6	SAB
7	SAB
8	SAB
9	SAB
10	SAB
11	SAB
12	SAB
13	SAB
14	SAB
15	SAB
16	SAB
17	SAB
18	SAB
19	SAB
20	SAB
21	SAB
22	SAB
23	SAB
24	SAB
25	SAB
26	SAB
27	SAB
28	SAB
29	SAB
30	SAB
31	SAB

Storia della Pizza Napoletana



Sta la genesi di questa meraviglia...
 La storia della pizza napoletana è...
 La pizza è un piatto che ha...
 La pizza è un piatto che ha...

La pizza è un piatto che ha...
 La pizza è un piatto che ha...
 La pizza è un piatto che ha...
 La pizza è un piatto che ha...



La pizza è un piatto che ha...
 La pizza è un piatto che ha...
 La pizza è un piatto che ha...
 La pizza è un piatto che ha...



GENNAIO



MAGGIO



SETTEMBRE



FEBBRAIO



GIUGNO



OTTOBRE



MARZO



LUGLIO



NOVEMBRE



APRILE



AGOSTO



DICEMBRE



AG 1892 PIZZA

Calendario mensile 12 fogli, Carta Patinata
 Stampa 4 colori fronte/retro, Festività
 Internazionali, Testata Termosaldata.

i Carta patinata 70 gr

o Calendario 28,8 x 47 cm
 Testata 28,8 x 9 cm

u 100

e 1,15





"Il lievito madre"

LA RICETTA

Il lievito madre è un prodotto a base di acqua e farina di grano duro o di grano tenero. Si prepara mescolando acqua e farina in una proporzione di 1:1 e si lascia fermentare per 24 ore a temperatura ambiente. Successivamente si aggiunge acqua e farina in una proporzione di 1:1 e si lascia fermentare per 24 ore a temperatura ambiente. Il lievito madre è un prodotto che si conserva in frigorifero per un periodo di tempo prolungato.

I rinfreschi

Il rinfresco è l'operazione di aggiungere acqua e farina al lievito madre per mantenerlo vivo. Si prepara mescolando acqua e farina in una proporzione di 1:1 e si lascia fermentare per 24 ore a temperatura ambiente. Il rinfresco deve essere fatto ogni 24 ore e deve essere fatto con la stessa proporzione di acqua e farina.

AG 1984
PANE
 Calendario mensile 12 fogli, Carta Patinata Stampa 4 colori fronte/retro, Festività Internazionali, Testata Termosaldata.





i Carta patinata 70 gr
🗨️ Calendario 28,8 x 47 cm
 Testata 28,8 x 9 cm
🍷 100
€ 1,15





**AG 1970
ECCELLENZE ITALIANE**

Calendario mensile 12 fogli, Carta Patinata
Stampa 4 colori fronte/retro, Festività
Internazionali, Testata Termosaldata.

-  Carta patinata 70 gr
-  Calendario 28,8 x 47 cm
Testata 28,8 x 9 cm
-  100
-  **1,15**





**AG 2023
CUCINA**

Calendario mensile 12 fogli, Carta Patinata
Stampa 4 colori fronte/retro, Festività
Internazionali, Testata Termosaldata.



Carta patinata 70 gr



Calendario 28,8 x 47 cm
Testata 28,8 x 9 cm



100



1,15



GENNAIO



FEBBRAIO



MARZO



APRILE



MAGGIO



GIUGNO



LUGLIO



AGOSTO



SETTEMBRE



OTTOBRE



NOVEMBRE



DICEMBRE





AG 2026 CARNE IN TAVOLA

Calendario mensile 12 fogli, Carta Patinata
Stampa 4 colori fronte/retro, Festività
Internazionali, Testata Termosaldata.



Carta patinata 70 gr



Calendario 28,8 x 47 cm
Testata 28,8 x 9 cm



100



1,15



GENNAIO



MAGGIO



SETTEMBRE



FEBBRAIO



GIUGNO



OTTOBRE



MARZO



LUGLIO



NOVEMBRE



APRILE



AGOSTO



DICEMBRE







AG 1987 FRUTTA & VERDURA

Calendario mensile 12 fogli, Carta Patinata
Stampa 4 colori fronte/retro, Festività
Internazionali, Testata Termosaldata.

 Carta patinata 70 gr

 Calendario 28,8 x 47 cm
Testata 28,8 x 9 cm

 100

 1,15



GENNAIO



MAGGIO



SETTEMBRE



FEBBRAIO



GIUGNO



OTTOBRE



MARZO



LUGLIO



NOVEMBRE



APRILE



AGOSTO



DICEMBRE



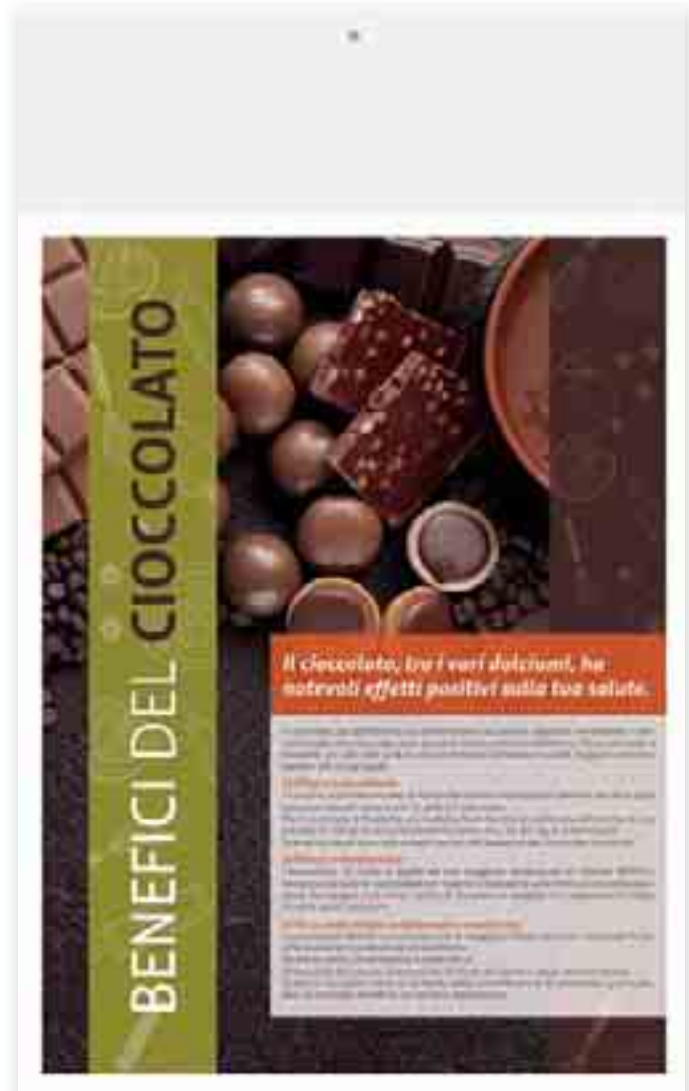

AG 1988 DOLCI E PIACERI

Calendario mensile 12 fogli, Carta Patinata
Stampa 4 colori fronte/retro, Festività
Internazionali, Testata Termosaldata.



Carta patinata 70 gr



Calendario 28,8 x 47 cm
Testata 28,8 x 9 cm



100



1,15



GENNAIO



LUGLIO



FEBBRAIO



AGOSTO



MARZO



SETTEMBRE



APRILE



OTTOBRE



MAGGIO



NOVEMBRE



GIUGNO



DICEMBRE





AG 1840 FORMULA UNO

Bimensile 6 fogli, carta patinata stampa 4 colori. Testata termosaldata.



Carta patinata 80 gr



Calendario 32 x 48 cm
Testata 32 x 10 cm



100



1,22





AG 1845 MOTO GP

Bimensile 6 fogli, carta patinata stampa 4 colori. Testata termosaldata.



Carta patinata 80 gr



Calendario 32 x 48 cm
Testata 32 x 10 cm



100







1,22





AG 2046 SILHOUETTE MILK & COFFEE

Calendario mensile 12 fogli, Carta Patinata
Stampa 4 colori fronte/retro, Festività
Internazionali, Testata Termosaldata.

-  Carta patinata 70 gr
-  Calendario 14 x 47 cm
Testata 14 x 9 cm
-  100
-  **0,71**







RETRO



AG 2049 SILHOUETTE CABALA

Calendario mensile 12 fogli, Carta Patinata
Stampa 4 colori fronte/retro, Festività
Internazionali, Testata Termosaldata.

-  Carta patinata 70 gr
-  Calendario 14 x 47 cm
Testata 14 x 9 cm
-  100
-  **0,71**

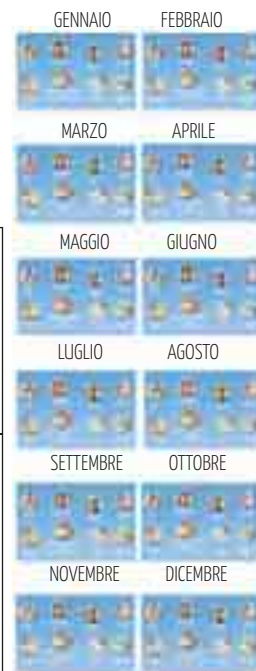



RETRO



RETRO



AG 2047
SILHOUETTE
CARNE IN TAVOLA
 Calendario mensile 12 fogli, Carta Patinata
 Stampa 4 colori fronte/retro, Festività
 Internazionali, Testata Termosaldata.

i Carta patinata 70 gr
o Calendario 14 x 47 cm
 Testata 14 x 9 cm
u 100
€ 0,71 



AG 2044
SILHOUETTE
CUCINA
 Calendario mensile 12 fogli, Carta Patinata
 Stampa 4 colori fronte/retro, Festività
 Internazionali, Testata Termosaldata.

i Carta patinata 70 gr
o Calendario 14 x 47 cm
 Testata 14 x 9 cm
u 100
€ 0,71 



RETRO



RETRO



**AG 2042
SILHOUETTE
SAN PIO**

Calendario mensile 12 fogli, Carta Patinata
Stampa 4 colori fronte/retro, Festività
Internazionali, Testata Termosaldata.

- Carta patinata 70 gr
- Calendario 14 x 47 cm
Testata 14 x 9 cm
- 100
- 0,71**



**AG 2045
SILHOUETTE
CITTA' D'ITALIA**

Calendario mensile 12 fogli, Carta Patinata
Stampa 4 colori fronte/retro, Festività
Internazionali, Testata Termosaldata.

- Carta patinata 70 gr
- Calendario 14 x 47 cm
Testata 14 x 9 cm
- 100
- 0,71**







RETRO



RETRO

**AG 2043
SILHOUETTE
CUCCIOLI**

Calendario mensile 12 fogli, Carta Patinata
Stampa 4 colori fronte/retro, Festività
Internazionali, Testata Termosaldata.

-  Carta patinata 70 gr
-  Calendario 14 x 47 cm
Testata 14 x 9 cm



 100

 **0,71**



**AG 2048
SILHOUETTE
FARMACIA**

Calendario mensile 12 fogli, Carta Patinata
Stampa 4 colori fronte/retro, Festività
Internazionali, Testata Termosaldata.

-  Carta patinata 70 gr
-  Calendario 14 x 47 cm
Testata 14 x 9 cm

 100

 **0,71**



RETRO







RETRO



AG 2040 SILHOUETTE MULTICOLOR





Calendario mensile 12 fogli, Carta Patinata
Stampa 4 colori fronte/retro, Planning 2023
sul retro dicembre, Festività Internazionali,
Testata Termosaldata.

-  Carta patinata 70 gr
-  Calendario 14 x 47 cm
Testata 14 x 9 cm
-  100
-  **0,60**



AG 2041 SILHOUETTE STYLE

Calendario mensile 12 fogli, Carta Patinata
Stampa 4 colori fronte/retro, Planning 2023
sul retro dicembre, Festività Internazionali,
Testata Termosaldata.

-  Carta patinata 70 gr
-  Calendario 14 x 47 cm
Testata 14 x 9 cm
-  100
-  **0,60**





AG 2051
OLANDESE MEDIO
MULTICOLOR

Calendario mensile 12 fogli, carta patinata.
Stampa 4 colori, Testata Termosaldata.



-  Carta patinata 80 gr
-  Calendario 22 x 9 cm
Testata 22 x 9 cm

 100
 0,96



AG 2055
OLANDESE
MEDIO STYLE

Calendario Mensile 12 fogli. Stampa 4
colori, testata termosaldada.

-  Carta patinata 80 gr
-  Calendario 22 x 47,4 cm
Testata 22 x 9 cm

 100
 0,96





BL

RETRO



RO



VE



AG 2010 OLANDESE MEDIUM

Calendario mensile 12 fogli, Carta Patinata,
Stampa 2 colori, Planning 2023 sul retro
dicembre, Festività Internazionali, Testata
Termosaldata.

 Carta patinata 70 gr

 Calendario 28,8 x 42,5 cm
Testata 28,8 x 9 cm

 100

 0,87



RO

RETRO



BL







VE



**AG 2011
OLANDESE STANDARD**

Calendario mensile 12 fogli, Carta Patinata, Stampa 2 colori, Planning 2023 sul retro dicembre, Festività Internazionali, Testata Termosaldata.

-  Carta patinata 70 gr
-  Calendario 28,8 x 47 cm
Testata 28,8 x 9 cm
-  100
-  1,00





BL

RETRO



RO



VE



AG 2012 OLANDESE NOTES

Calendario mensile 12 fogli, Carta Patinata,
Stampa 2 colori, Planning 2023 sul retro
dicembre, Festività Internazionali, Testata
Termosaldata.

 Carta patinata 70 gr

 Calendario 28,8 x 47 cm
Testata 28,8 x 9 cm

 100

 1,00



RO



RETRO



BL



VE



AG 2015 OLANDESE TRENDY

Calendario mensile 12 fogli, Carta Patinata,
Stampa 2 colori, Planning 2023 sul retro
dicembre, Festività Internazionali, Testata
Termosaldata.

 Carta patinata 70 gr

 Calendario 28,8 x 47 cm
Testata 28,8 x 9 cm

 100

 1,00









RETRO



AG 2014 OLANDESE STANDARD MULTICOLOR

Calendario mensile 12 fogli, Carta Patinata,
Stampa 2 colori, Planning 2023 sul retro
dicembre, Festività Internazionali, Testata
Termosaldata.

-  Carta patinata 70 gr
-  Calendario 28,8 x 47 cm
Testata 28,8 x 9 cm
-  100
-  1,00









RETRO



AG 2013 OLANDESE NOTES MULTICOLOR

Calendario mensile 12 fogli, Carta Patinata,
Stampa 4 colori, Planning 2023, sul retro
dicembre, Festività Internazionali, Testata
Termosaldata.





-  Carta patinata 70 gr
-  Calendario 28,8 x 47 cm
Testata 28,8 x 9 cm
-  100
-  1,00





AG 2057 OLANDESE STYLE



Calendario mensile 12 fogli, Carta Patinata, Stampa 4 colori, Planning 2023 sul retro dicembre, Festività Internazionali, Testata Termosaldata.

-  Carta patinata 70 gr
-  Calendario 28,8 x 47 cm
Testata 28,8 x 9 cm
-  100
-  **1,02**



AG 2041 SILHOUETTE STYLE

Calendario mensile 12 fogli, Carta Patinata Stampa 4 colori fronte/retro, Planning 2023 sul retro dicembre, Festività Internazionali, Testata Termosaldata.



-  Carta patinata 70 gr
-  Calendario 14 x 47 cm
Testata 14 x 9 cm
-  100
-  **0,60**





**AG 2055
OLANDESE
MEDIO STYLE**

Calendario Mensile 12 fogli. Stampa 4 colori, testata termosaldata.

-  Carta patinata 80 gr
-  Calendario 22 x 47,4 cm
Testata 22 x 9 cm



 100

 0,96



**AG 2083
CALENDARIO
DA TAVOLO STYLE**

Spiralato 12 fogli + copertina carta patinata. Planning 2022 sul retro.

-  Carta patinata 100 gr
-  Calendario 12 x 19,5 cm
Spazio Stampa 12,5 x 4 cm

 100

 0,66



RO



**AG 2035
MAXI OLANDESE NOTE**
Mensile 12 fogli, carta uso mano 80 gr.
stampa 2 colori. Testata doppio strato rinforzata.

-  Carta uso mano 80 gr
-  Calendario 31 x 53 cm
Testata 31 x 10,8 cm
-  100
-  **1,19**



BL



RO



AG 2031 PASSAFOGLI

Mensile 12 fogli, carta uso mano 90 gr. stampa 2 colori. Testata doppio strato rinforzata.



Carta uso mano 90 gr



Calendario 34 x 54 cm
Testata 34 x 9 cm



100



1,56





AG 2032 PASSAFOGLI

Mensile 12 fogli, carta patinata opaca, stampa
2 colori. Testata doppio strato rinforzata.
Allestito con astina in metallo.

 Carta patinata opaca 90 gr

 Calendario 34 x 55 cm
Testata 34 x 9 cm

 100

 1,65



BL

RO

VE



**AG 2033
PASSAFOGLI**

Mensile 12 fogli, carta patinata opaca. stampa 2 colori. Testata doppio strato rinforzata. Allestito con astina in metallo.

Carta patinata opaca 90 gr

Calendario 32,5 x 54 cm
Testata 32,5 x 9 cm

100

1,65





RO

AR



BL



VE



AG 2016 PORTOGHESE MAXI

Calendario mensile 12 fogli . Carta patinata
stampa 2 colori. **Testata rigida rinforzata** in triplo
cartoncino.

 Carta patinata 90 gr

 Calendario 31 x 53 cm
Testata 31 x 10,8 cm

 100

 1,50



RO



AR



BL



VE



AG 2072 PORTOGHESE DA TAVOLO

Spiralato 13 fogli carta patinata. Planning 2023 sul retro.

 Carta patinata opaca 100 gr

 Calendario 19 x 14 cm
Spazio Stampa 19 x 4 cm

 100



 0,63





AG 2084 TRICOLORE DA TAVOLO

Spiralato 13 fogli carta patinata. Planning 2023 sul retro.



-  Carta patinata 100 gr
-  Calendario 19 x 14 cm
-  Spazio Stampa 19 x 4 cm

 100
 **0,69**



AG 1994 TRICOLORE

Calendario mensile 12 fogli, Carta patinata. Testata rinforzata.

-  Carta patinata opaca 90 gr
-  Calendario 31 x 53 cm
-  Testata 31 x 10,8 cm

 100
 **1,49**



1 S	1 4 6 9 B	52° set	DICEMBRE 2021
2 D	ss. Maria Madre di Dio - Capodanno		Set 48 49 50 51 52
3 L	ss. Basilio e Gregorio		Lun 6 13 20 27
4 M	ss. Genoveffa	1° set	Mar 7 14 21 28
5 M	ss. Ermes e Cato		Mer 1 8 15 22 29
6 G	ss. Arnella		Gio 2 9 16 23 30
7 V	ss. Ermete e Cato		Ven 3 10 17 24 31
8 S	ss. Raimondo di Peñafort		Sab 4 11 18 25
9 D	ss. Alessio		Dom 5 12 19 26
10 L	Battesimo di Gesù	2° set	
11 M	ss. Aldo		
12 M	ss. Igino		
13 G	ss. Cosma		
14 V	ss. Gero		
15 S	ss. Felice		
16 D	ss. Mauro		
17 L	ss. Marcello	3° set	
18 M	ss. Antonio abate		
19 M	ss. Liberata - ss. Margherita	4° set	
20 G	ss. Sebastiano e Fabiano		
21 V	ss. Agnese		
22 S	ss. Vincenzino e Caudarato		
23 D	ss. Emerenziana		
24 L	ss. Francesco di Sales	5° set	
25 M	Conversione di s. Paolo		
26 M	ss. Tito e Timoteo		
27 G	ss. Angela Merici		
28 V	ss. Tommaso d'Aquino		
29 S	ss. Costanzo		
30 D	ss. Martina		
31 L	ss. Giovanni Bosco	6° set	

gen	20
io	22

FEBBRAIO 2022
Set 06 07 08 09 10
Lun 7 14 21 28
Mar 1 8 15 22
Mer 2 9 16 23
Gio 3 10 17 24
Ven 4 11 18 25
Sab 5 12 19 26
Dom 6 13 20 27

Il Sole e la Luna

☉ Giorno 1 ore 7,37 ore 16,49
 ☉ Giorno 10 ore 7,37 ore 16,58
 ☉ Giorno 20 ore 7,32 ore 17,09
ore: in Italia agli 8° meridiali, per ogni longitudine
 nel calendario il risultato sempre della stessa

☾ L.N. giorno 2 ore 19,33
 ☾ P.Q. giorno 9 ore 19,11
 ☾ L.P. giorno 18 ore 00,48
 ☾ U.Q. giorno 25 ore 14,40



INCHIOSTRI FLUO

**AG 2054
 SILHOUETTE
 MULTIFLUO**

Calendario mensile 12 fogli, Carta Patinata
 Stampa 4 colori fluo. Festività Internazionali,
 Testata Termosaldata.

i Carta patinata 100 gr

o Calendario 14,7 x 49 cm
 Testata 14,7 x 10,2 cm

u 100

€ 0,75



1 S 1469B 52ª settimana
Maria Madre di Dio - Capodanno 1-364

2 D
ss. Basilio e Gregorio 2-363

3 L 1ª settimana
s. Genoveffa 3-362

4 M
ss. Ermite e Calo 4-361

5 M
s. Amalia 5-360

6 G 4B
Epifania di N.S. 6-359

7 V
s. Raimondo di Penafort 7-358

8 S
s. Massimo 8-357

9 D
Battesimo di Gesù 9-356

10 L 2ª settimana
s. Aldo 10-355

11 M
s. Iginio 11-354

12 M
s. Cesira 12-353

13 G
s. Ilario 13-352

14 V
s. Felice 14-351

15 S
s. Mauro 15-350

16 D
s. Marcello 16-349

17 L 3ª settimana
s. Antonio abate 17-348

18 M
s. Liberata - s. Margherita 18-347

19 M
s. Mario e Marta 19-346

20 G
ss. Sebastiano e Fabiano 20-345

21 V
s. Agnese 21-344

22 S
s. Vincenzo e Caudenzio 22-343

23 D
s. Emerenziana 23-342

24 L 4ª settimana
s. Francesco di Sales 24-341

25 M
Conversione di s. Paolo 25-340

26 M
ss. Tito e Timoteo 26-339

27 G
s. Angela Merici 27-338

28 V
s. Tommaso d'Aquino 28-337

29 S
s. Costanzo 29-336

30 D
s. Martina 30-335

31 L 5ª settimana
s. Giovanni Bosco 31-334

ACQUARIO
21/01 - 19/02

gennaio

2022

Il Sole e la Luna

Calendo 1 ore 2:27	ora 14:49	☾ 1.8. giorno 2 ore 19:21
Calendo 10 ore 7:27	ora 14:36	☾ 7.0. giorno 9 ore 19:11
Calendo 20 ore 7:22	ora 14:20	☾ 13.0. giorno 16 ore 19:01
Calendo 30 ore 7:17	ora 14:03	☾ 19.0. giorno 23 ore 18:51

Dicembre 2021

Lun	Mar	Mer	Gio	Ven	Sab	Dom
		1	2	3	4	5
6	7	8	9	10	11	12
13	14	15	16	17	18	19
20	21	22	23	24	25	26
27	28	29	30	31		

Febbraio 2022

Lun	Mar	Mer	Gio	Ven	Sab	Dom
		1	2	3	4	5
6	7	8	9	10	11	12
13	14	15	16	17	18	19
20	21	22	23	24	25	26
27	28					

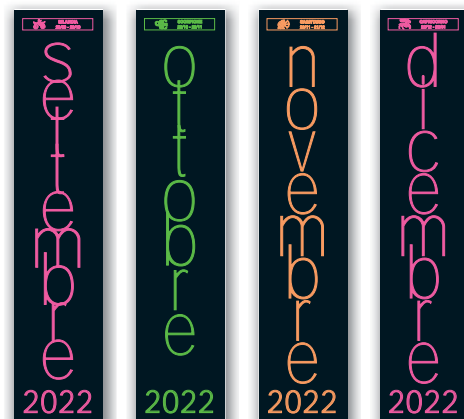
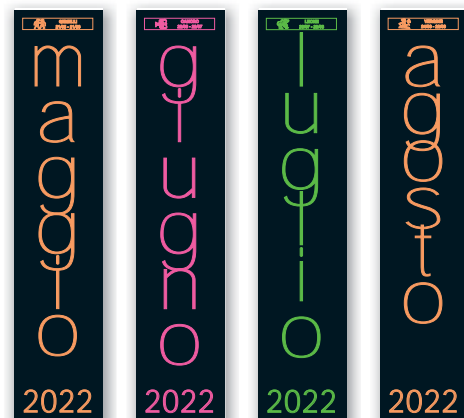
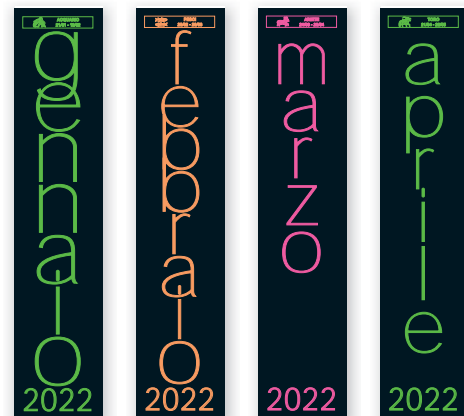

**AG 2058
OLANDESE MULTIFLUO
BLACK**

Calendario mensile 12 fogli, Carta Patinata, Stampa 4 colori fluo. Festività Internazionali, Testata Termosaldata.

- Carta patinata 100 gr
- Calendario 31 x 49 cm
Testata 31 x 10 cm
- 100
- 1,65**



INCHIOSTRI FLUO

DICEMBRE 2021	
Set	48 49 50 51 52
Lun	6 13 20 27
Mar	7 14 21 28
Mer	1 8 15 22 29
Gio	2 9 16 23 30
Ven	3 10 17 24 31
Sab	4 11 18 25
Dom	5 12 19 26

FEBBRAIO 2022	
Set	06 07 08 09 10
Lun	7 14 21 28
Mar	1 8 15 22
Mer	2 9 16 23
Gio	3 10 17 24
Ven	4 11 18 25
Sab	5 12 19 26
Dom	6 13 20 27

Il Sole e la Luna	
☉	Giorno 1 ore 7,37 ore 16,49
☉	Giorno 10 ore 7,37 ore 16,58
☉	Giorno 20 ore 7,52 ore 17,09
☉	Nota: la velocità del Sole è costante per tutti i giorni, ma la lunghezza del giorno varia a causa della inclinazione dell'asse terrestre.
☾	L.N. giorno 2 ore 19,33
☾	P.O. giorno 9 ore 19,31
☾	L.P. giorno 18 ore 00,48
☾	U.O. giorno 25 ore 14,40

gen
na
20
22

feb
bra
20
22

mar
zo
20
22

apri
le
20
22

mag
gio
20
22

giu
gno
20
22

lug
lio
20
22

ago
sto
20
22

set
tem
bre
20
22

otto
bre
20
22

nov
em
bre
20
22

dic
em
bre
20
22

AG 2059 SILHOUETTE MULTIFLUO BLACK

Calendario mensile 12 fogli, Carta Patinata
Stampa 4 colori fluo. Festività Internazionali,
Testata Termosaldata.

 Carta patinata 100 gr

 Calendario 14,7 x 49 cm
Testata 14,7 x 10,2 cm

 100

 0,81



INCHIOSTRI FLUO



AG 2062 TRITTIKO BLACK





Trimestrale 12 fogli in carta patinata,
testata rinforzata, cursore incluso.

-  Carta patinata 80 gr
-  Calendario 33 x 79 cm
Testata 33 x 20 cm
-  100
-  **3,99**



AG 2065 TRITTIKO

Trimestrale 12 fogli in carta patinata,
testata rinforzata, cursore incluso.

-  Carta patinata 80 gr
-  Calendario 33 x 79 cm
Testata 33 x 20 cm
-  100
-  **3,45**



RO

VE

 GENNAIO 2022	
1 SABATO	17 LUNEDI
2 DOMENICA	18 MARTEDI
3 LUNEDI	19 MERCOLEDI
4 MARTEDI	20 GIOVEDI
5 MERCOLEDI	21 VENERDI
6 GIOVEDI	22 SABATO
7 VENERDI	23 DOMENICA
8 SABATO	24 LUNEDI
9 DOMENICA	25 MARTEDI
10 LUNEDI	26 MERCOLEDI
11 MARTEDI	27 GIOVEDI
12 MERCOLEDI	28 VENERDI
13 GIOVEDI	29 SABATO
14 VENERDI	30 DOMENICA
15 SABATO	31 LUNEDI
16 DOMENICA	

 GENNAIO 2022	
1 SABATO	17 LUNEDI
2 DOMENICA	18 MARTEDI
3 LUNEDI	19 MERCOLEDI
4 MARTEDI	20 GIOVEDI
5 MERCOLEDI	21 VENERDI
6 GIOVEDI	22 SABATO
7 VENERDI	23 DOMENICA
8 SABATO	24 LUNEDI
9 DOMENICA	25 MARTEDI
10 LUNEDI	26 MERCOLEDI
11 MARTEDI	27 GIOVEDI
12 MERCOLEDI	28 VENERDI
13 GIOVEDI	29 SABATO
14 VENERDI	30 DOMENICA
15 SABATO	31 LUNEDI
16 DOMENICA	

**AG 2060
OLANDESE MAXI
QUADRETTATO**

Mensile 12 fogli. Allestimento con astina metallica.



Carta uso mano 80 gr



Calendario 33 X 70 cm
Testata 33 x 11 cm



100



1,95





**AG 2085
CALENDARIO
TRIMESTRALE
DA TAVOLO**

Spiralato 13 fogli patinata. Planning 2023 sul retro.



Carta patinata 100 gr



Calendario 19 x 14 cm
Spazio Stampa 19 x 4 cm



100



0,63



RO



AR



BL



VE



AG 2072 PORTOGHESE DA TAVOLO

Spiralato 13 fogli carta patinata. Planning 2023 sul retro.

 Carta patinata opaca 100 gr

 Calendario 19 x 14 cm
Spazio Stampa 19 x 4 cm

 100





 0,63





AG 2080
CALENDARIO
TRIMESTRALE
DA TAVOLO



Spiralato 13 fogli carta patinata. Planning 2023 sul retro.

-  Carta patinata 100 gr
-  Calendario 19 x 14 cm
Spazio Stampa 19 x 4 cm
-  100
-  **0,66**



AG 2081
CALENDARIO
TRIMESTRALE
DA TAVOLO

Spiralato 13 fogli carta patinata. Planning 2023 sul retro.

-  Carta patinata 100 gr
-  Calendario 19 x 14 cm
Spazio Stampa 19 x 4 cm
-  100
-  **0,66**





AG 2084 TRICOLORE DA TAVOLO

Spiralato 13 fogli carta patinata. Planning 2023 sul retro.

-  Carta patinata 100 gr
-  Calendario 19 x 14 cm
Spazio Stampa 19 x 4 cm
-  100
-  **0,69**



AG 2083 CALENDARIO DA TAVOLO STYLE

Spiralato 12 fogli + copertina carta patinata. Planning 2022 sul retro.

-  Carta patinata 100 gr
-  Calendario 12,5 x 19,5 cm
Spazio Stampa 12,5x 4 cm
-  100
-  **0,66**



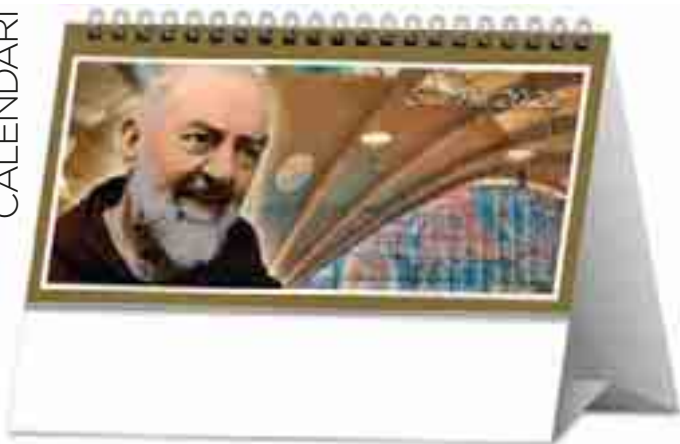

AG 2075 SAN PIO CALENDARIO DA TAVOLO

Spiralato 13 fogli carta patinata.
Planning 2023 sul retro.

-  Carta patinata 100 gr
-  Calendario 19 x 14 cm
Spazio Stampa 19 x 4 cm
-  100
-  **0,75**



AG 2079 CITTA' D'ITALIA CALENDARIO DA TAVOLO

Spiralato 13 fogli carta patinata.
Planning 2023 sul retro.

-  Carta patinata 100 gr
-  Calendario 19 x 14 cm
Spazio Stampa 19 x 4 cm
-  100
-  **0,75**



AG 2073 AUTO SPORTIVE CALENDARIO DA TAVOLO

Spiralato 13 fogli carta patinata.
Planning 2023 sul retro.

-  Carta patinata 100 gr
-  Calendario 19 x 14 cm
Spazio Stampa 19 x 4 cm
-  100
-  **0,75**



AG 2078 CANI E GATTI CALENDARIO DA TAVOLO

Spiralato 13 fogli carta patinata.
Planning 2023 sul retro.

-  Carta patinata 100 gr
-  Calendario 19 x 14 cm
Spazio Stampa 19 x 4 cm
-  100
-  **0,75**





AG 2090 PLANNING MAXI

50 fogli carta uso mano.

 Carta uso mano 80 gr

 43x31 cm
Testata 43 x 4 cm

 25

 **4,44**



AG 2086 PLANNING MEDIO

50 fogli carta uso mano.

 Carta uso mano 80 gr

 30 x 21 cm
Testata 30 x 3 cm

 25

 **2,76**



AG 2087 MINI PLANNING

50 fogli carta uso mano.

 Carta uso mano 80 gr

 30x14,5 cm
Testata 30x3 cm

 50

 **2,37**





PENNE

promosolution
2021|2022

 PARKER



JOTTER



RY



VE



FX



AR

 PARKER

**AL 2148
PARKER JOTTER**

Parker, penna a sfera Jotter in acciaio inossidabile e plastica, finiture cromate, meccanismo a scatto, elegante confezione regalo. Refil blu

 ABS/ Metallo

 1/50

 **13,50**

UN BRAND CLASSICO

COMPLETO DI BOX REGALO



NE



BL



BO



BI

 PARKER

**AL 2147
PARKER JOTTER**

Parker, penna a sfera Jotter in acciaio inossidabile e plastica, finiture cromate, meccanismo a scatto, elegante confezione regalo. Refil nero

 ABS/ Metallo

 1/50

 **13,50**



NE



ROLLER con astuccio *in Ottone laccato*



 PARKER

AL 2138 PARKER IM

Penna roller in ottone laccato con finiture cromate. Corredata di astuccio. Refil Nero

-  Ottone
-  1/10
-  **82,50**



NE

BL

AZ



BIRO con astuccio *in Ottone laccato*



 PARKER

AL 2134 PARKER IM

Penna biro in ottone laccato con finiture cromate. Corredata di astuccio. Refil Blu.

-  Ottone
-  1/10
-  **65,85**

Stilografica, Biro e Portamine

UNA PARKER JOTTER PER OGNI ESIGENZA



 PARKER

AL 2140 PARKER JOTTER CORE

Penna stilografica Jotter Core in acciaio inossidabile con cappuccio, finiture cromate, refill blu. Confezione in astuccio

 Acciaio
 1/10
 **66,00**



 PARKER

AL 2130 PARKER JOTTER PENNA

Penna in acciaio con meccanismo a scatto. Refil blu. Confezione in astuccio.

 Acciaio
 1/20
 **23,70**



 PARKER

AL 2131 PARKER JOTTER PREMIUM PORTAMINE

Portamine in acciaio con mina da 0,5 mm. Confezione in astuccio.

 Acciaio
 1/20
 **26,70**

HUGO BOSS



FESTINA



FESTINA

**AL 2116
PENNA BIRO FESTINA**

in alluminio con una texture spazzolata e dettagli metallici cromati, la penna a sfera Chronobike, unisce un look sportivo a una sensazione raffinata. Refil nero.

i Alluminio

1/10

€ 36,87



GI

UNA BIRO
SPORTIVA
*con una raffinata
lavorazione in alluminio*



AZ

RO

NE

HUGO BOSS

**AL 2109
BIRO HUGO BOSS**

Penna biro in ottone rivestito in rubber soft touch con finiture in metallo laccato nero opaco. Confezione in astuccio. Refil blu

i Ottone rivestito in rubber

1/10

€ 54,00

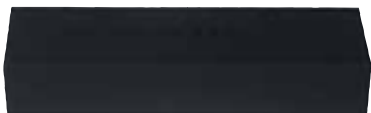

NE

BIRO IN
OTTONE
*rivestita in
rubber
soft touch*



VE

BL

AZ

RO

HUGO BOSS ROLLER IN OTTONE con astuccio

AL 2114 PENNA HUGO BOSS

Penna roller in ottone realizzata con un raffinato motivo a spina di pesce, impreziosita da particolari cromati. Corredata di astuccio. Refil nero.

-  Ottone
-  1/10
-  **63,00**



HUGO BOSS ROLLER IN OTTONE rivestimento gommato CON ASTUCCIO

AL 2115 PENNA HUGO BOSS

Penna biro in ottone rivestito in rubber soft touch con finiture in metallo laccato nero opaco. Confezione in astuccio. Refil blu

-  Ottone rivestito in rubber
-  1/10
-  **69,00**

BIRO
con incisione
HUGO BOSS

HUGO BOSS

AL 2104
BIRO HUGO BOSS

Penna biro in ottone laccato con finiture silver e logo HUGO BOSS inciso sul fusto. Corredata di astuccio. Refil blu.

 **Ottone**

 **1**

 **54,00**



BIRO
con rivestimento
IN POLIURETANO

HUGO BOSS

AL 2110
BIRO HUGO BOSS

Penna biro in ottone rivestito in poliuretano con finiture in metallo lucido. Confezione in astuccio. Refil blu.

 **Ottone rivestito in poliuretano**

 **1**

 **58,50**





LAVILLE® PARIS

AL 2158 PENNA MULTIFUNZIONE

Penna multifunzione dotata di righello, livella, cacciavite e puntatore gommato per l'uso su tablet e cellulari. Confezionata in box regalo.

i Metallo

🔧 1/10

€ 9,90

PENNE LAVILLE MULTIFUNZIONI



LAVILLE® PARIS

AL 2161 PENNA MULTIFUNZIONE

Un pratico accessorio realizzato in metallo cromato e satinato che combina 4 differenti funzioni: Portachiavi - Penna a sfera - Puntatore "touch" - Gettone per carrello spesa - Confezionato in una prestigiosa confezione in metallo argentato.

i Metallo

🔧 1/20

€ 7,95



**AL 2218
VALENCIA**

Penna a sfera in alluminio, completa di astuccio, refill nero.

-  Alluminio
-  1/50
-  **4,35**

**BIRO COMPLETA DI
ASTUCCIO IN TINTA**

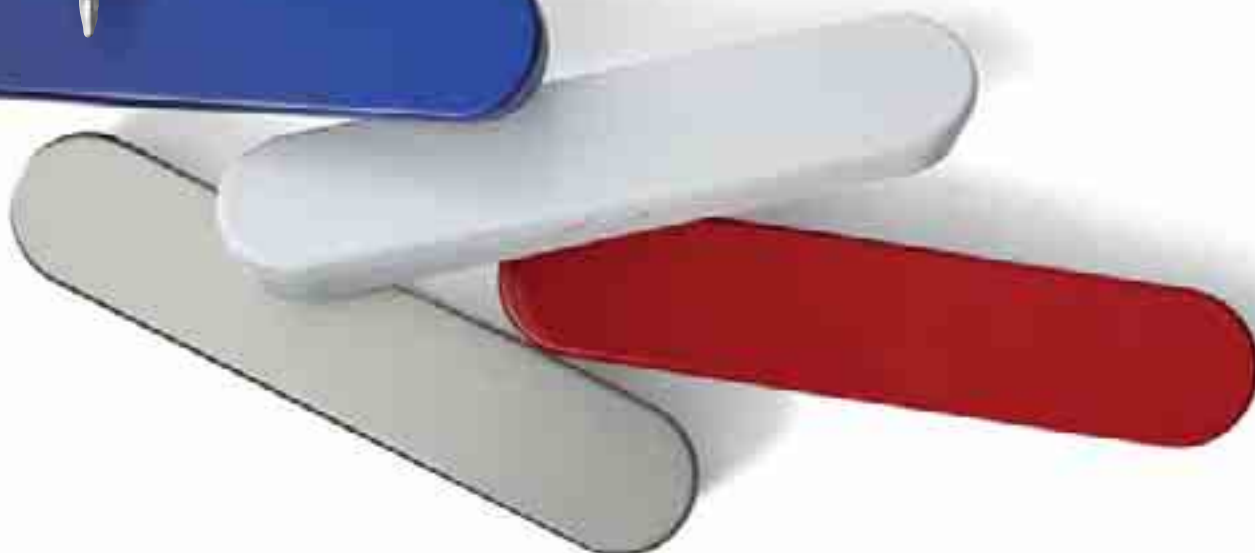



PENNA CON TOUCH REFIL NERO

AL 2200 BAHAMAS

Penna a sfera con touch, fusto in alluminio doppio strato di laccatura: primo strato nero e secondo strato dello stesso colore del touch, refil nero.

-  Alluminio
-  50/500
-  1,05

PENNE IN ALLUMINIO CON DOPPIO STRATO DI LACCATURA



AL 2188 MAURITIUS

Penna in metallo con doppio strato di laccatura: primo strato nero e secondo strato dello stesso colore del pulsante. Refil blu.

-  Alluminio
-  50/500
-  0,87

PENNA REFIL BLU

**AL 2154
DUBAI**

Penna a sfera in alluminio con finiture argentate.
Refil blu.

i Alluminio

♻️ 50/500

€ 0,96

AZ



NE



RO



VE



SI

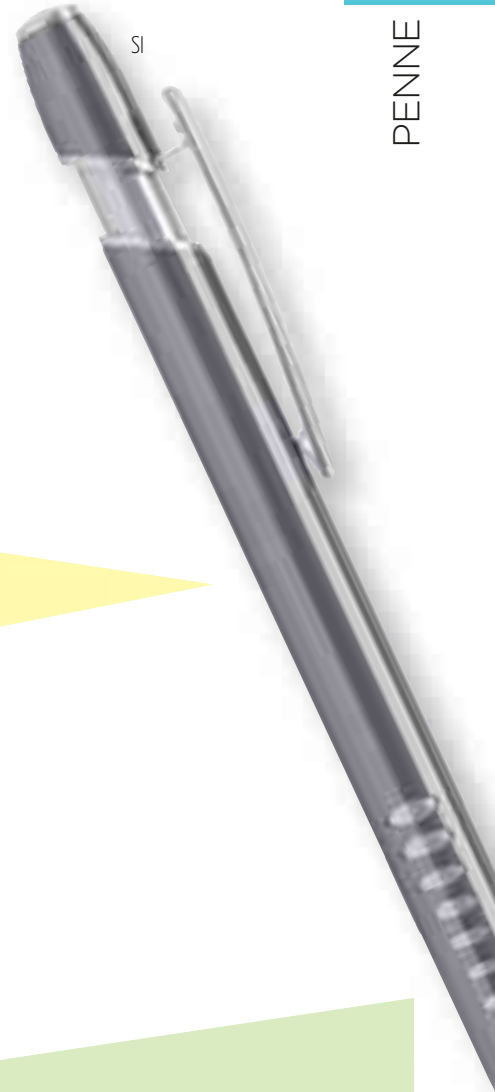

**BIRO CON
FINITURE
ARGENTATE**

**BIRO CON
FUSTO
VERNICIATO**

**AL 2190
MANILA**

Penna in alluminio con fusto verniciato e finiture
nero opaco. Refil nero.

i Alluminio

♻️ 50/500

€ 0,87

GR



NE



BO



RO



RY



VE



SI



BO

BL

NE

RO

AR

VE

SI

**AL 2192
BREMA**

Penna a sfera in alluminio con Refil nero.

i Alluminio**♻️** 50/500**€** 0,69**BIRO IN
ALLUMINIO***Touch screen*

SI

**BIRO IN
ALLUMINIO****AL 2195
AMBURGO**

Penna a sfera touch in alluminio. Refil nero

i Alluminio**♻️** 50/500**€** 0,79

BL

NE

RO

VE

BO



NE



AL 2253 MONACO

Penna a sfera in plastica con particolari in metallo. Refil nero

 Plastica e metallo

 50/1000

 **0,39**

AL 2251 COLONIA

Penna a sfera touch in plastica con particolari in metallo. Refil nero

 Plastica e metallo

 50/1000

 **0,45**



BL

NE

RO

VE

VM

BO

SI

BI

AR



Touch screen



SI

Touch screen

AL 2165 TOKYO

Penna a sfera touch in alluminio, refill blu.

 Alluminio

 50/500

 0,98

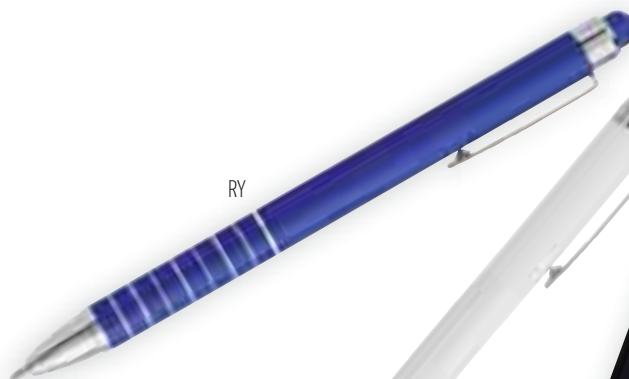

RY



BI



NE



RO



AR



RO



VE



BL



BI

AL 2180 SMART

Penna a sfera touch sottile in alluminio lucido. Refil nero.

 Alluminio

 50/500

 0,87

Touch screen



NE

AL 2175 PENNA LEIDA

Penna sfera in metallo laccato, clip e puntale in tinta con l'impugnatura a strisce in gomma, meccanismo a scatto, refill blu.

i Metallo

👤 50/500

€ 0,87



Touch screen

AL 2176 PENNA LUGANO

In alluminio touch con triplo refill (blu - nero - rosso).

i Alluminio

👤 50/100

€ 0,99



**PENNA CON
TRIPLO REFIL
BLU NERO ROSSO**



BI

NE

VE

BL

RO

GI

AL 2235 LILIA

Penna a sfera in plastica solid e clip in metallo,
refil nero.

 Platica e Metallo

 50/1000

 **0,96**



PENNE A SFERA MADE IN ITALY



NE

BL

BO

NN

BD

AL 2240 LILIA GOLD

Penna a sfera in plastica solid e dorata, clip in
metallo. Refil nero.

 Platica e Metallo

 50/1000

 **1,38**





stilolinea
**AL 2225
PENNA S!**

Penna a sfera In ABS bianco con particolari colorati. Refil blu.

 Platica e Metallo

 100/1000

 **0,36**

PENNE A SFERA

MADE IN ITALY



stilolinea
**AL 2223
PENNA BARON**

Penna a sfera In ABS bianco con particolari colorati. Refil blu.

 Platica e Metallo

 100/1000

 **0,54**



frosty multicolor

**AL 2220
ROMA**

Penna a sfera in plastica solid e frosty. Refil Nero

i Plastica

♻️ 100/1000

€ 0,39



PENNE A SFERA
MADE IN ITALY

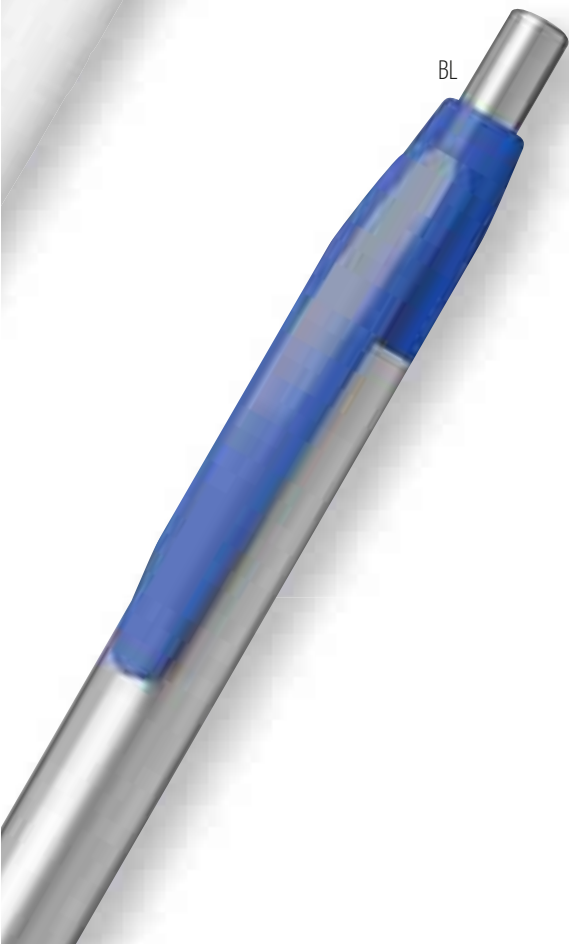

**AL 2227
ROMA SILVER**

Penna a sfera in plastica silver. Refil Nero.

i Plastica

♻️ 100/1000

€ 0,48



fusto in silver

RO

AR

BI

BL

VE

PENNA A SFERA IN ABS atossico

AL 2228 EXTRA SOLID

Penna a sfera in ABS atossico e clip trasparente frost in Terluc atossico. Scrittura 2 Km - Sfera ø 1 mm Inchiostro Dokumental atossico. Refil blu.

 ABS

 100/1000

 0,48



clip trasparente

PENNE A SFERA MADE IN ITALY

NE

RO

AR

BI

BL

VE

PENNA A SFERA IN ABS atossico

AL 2229 EXTRA RECYCLED

Penna a sfera in ABS riciclato atossico. Scrittura 2 Km - Sfera ø 1 mm Inchiostro Dokumental atossico. Refil blu

 ABS

 100/1000

 0,53



Greenline
100% recycled



PENNA A SFERA

CON

Touch Screen



SI

GI

AR

RO



VE

NE

BI

BL



AL 2248 LONDRA

Penna a sfera touch in plastica con clip in metallo e refill nero.

i Plastica e Metallo

♻️ 50/1000

€ 0,42

**AL 2242
BOSTON**

Penna sfera in plastica con touch e led interno a luce bianca, apertura a rotazione, refill blu.

i Plastica e metallo

♻️ 50/1000

€ 1,17

PENNA CON LED INTERNO



Touch screen



SI

**AL 2249
PARIGI**

Penna sfera in plastica con touch. Refil nero.

i Plastica

♻️ 50/1000

€ 0,42



Touch screen

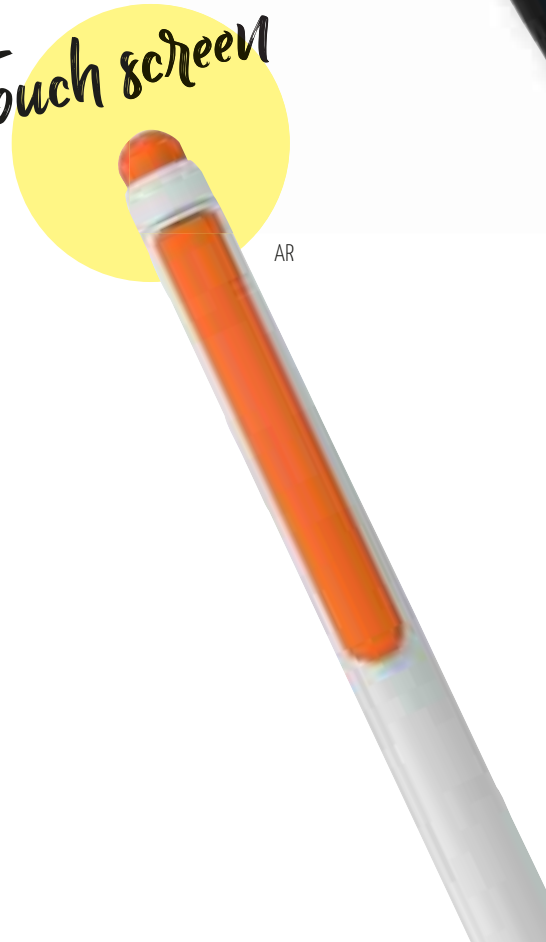

AR

PENNA A SFERA CON

Touch Screen



SI



BI



BL



VI



FX



VE



RO



AR



NE



GI

AL 2245 BROOKLYN

Penna a sfera touch in plastica e metallo
refil nero.



Plastica e Metallo



50/1000



0,39

PENNA A SFERA

CON

Touch Screen

LEGGERMENTE APPIATTITA PER FACILITARE LA STAMPA DIGITALE

NE

VM

VE

RO

GI

AZ

BL

AL 2246 CUBA

Penna a sfera touch in plastica con particolari in metallo. Refil nero

i Plastica e Metallo

♻️ 50/1000

€ 0,45

PENNA A SFERA CON

Impugnatura Gommata

NE

BI

VM

VE

RO

AR

GI

AZ

BL

AL 2255 AMALFI

Penna in plastica con clip in metallo. Refil nero.
Impugnatura in plastica gommata.

i Plastica e Metallo

♻️ 50/1000

€ 0,30

PENNA BIRO IN ABS

Antibatterico



VM

NE

VE

RO

AR

GI

AZ

BL



AL 2258 VIETRI

Penna in ABS antibatterico con clip in metallo.
Impugnatura traslucida. Refil Nero.

i ABS antibatterico

♻️ 50/1000

€ 0,40

PENNA A SFERA CON CLIP IN METALLO



AL 2256 POSITANO

Penna in plastica semitrasparente con clip in metallo. Refil nero. Impugnatura in plastica gommata

 **Plastica e Metallo**

 **50/1000**

 **0,30**

BIRO SILVER

CON
PARTICOLARI
IN METALLO



GI

AL 2254 NEW YORK

Penna a sfera in plastica silver con particolari in metallo. Refil nero

i Plastica e Metallo

♻️ 50/1000

€ 0,30



NE

BO

RO

AR

VM

VE

AZ

BL

VI

PENNA A SFERA IN PLASTICA REFIL NERO



AR



SI



BO



GI



VE



BL



NE



BI

AL 2360 MANILA

Penna a sfera in plastica argentata e solid, refill nero.

i Plastica

♻️ 50/1000

€ 0,29

BIRO CON CLIP IN METALLO



NE

RY

AZ

VE

VM

BO

RO



AR

GI

FX

RS

BI

CR

AL 2355 MITO

Penna a sfera in plastica con clip in metallo.
Refil nero



Plastica e Metallo



50/1000



0,29

BIRO IN PLASTICA REFIL NERO



AR

GI

VM

VE

BL

RY

RS

NE

RO

AL 2350 OSAKA

Penna in plastica con clip in metallo. Refil Nero

i Plastica

♻️ 50/1000

€ 0,29

**AL 2272
LIVERPOOL**

Penna ink-gel in plastica bianca con particolari colorati, chiusura con tappo. Refil nero.

i Plastica

♻️ 50/1000

€ 0,49

BL



PENNA INK-GEL



VE

AR

RO

BI

NE

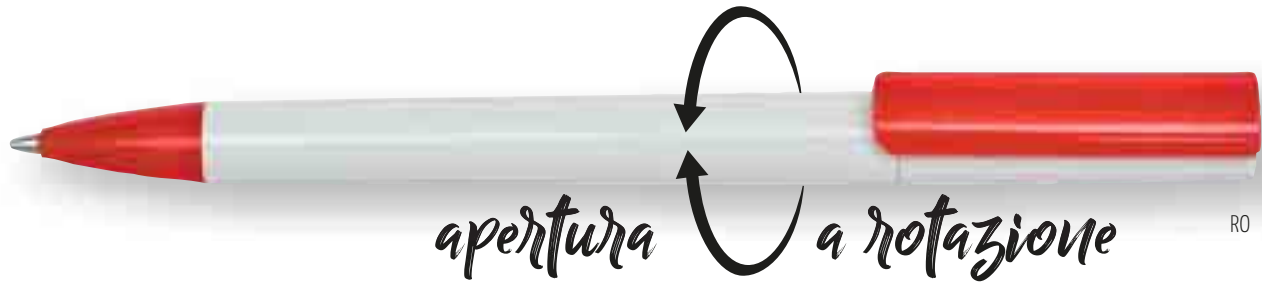

RO



AL 2275 LISBONA

Penna sfera in plastica con meccanismo a rotazione. Refil nero.

 Plastica

 50/1000

 0,23



AL 2265 MALAGA

Penna a scatto in plastica bianca con particolari colorati. Refil nero

 Plastica

 50/1000

 0,33

particolari colorati





**AL 2268
MANCHESTER**

Penna a scatto in plastica bianca con particolari colorati. Refil nero

-  Plastica
-  50/1000
-  0,29

**AL 2301
ATLANTA**

Penna sfera con fusto in ABS bianco con finiture colorate. Refil nero.

-  Plastica
-  50/1000
-  0,39



AL 2325 NEW JERSEY

Penna a sfera in plastica con impugnatura in gomma. Refil nero

-  Plastica
-  50/1000
-  **0,33**



impugnature gommata



AL 2310 PORTORICO

Penna a sfera in plastica con impugnatura in gomma. Refil nero

-  Plastica
-  50/1000
-  **0,28**

AR

PENNA SANTIAGO CON FINITURE A COLORI

AL 2326 SANTIAGO

Penna sfera con corpo in plastica. Refil nero.

-  Plastica
-  50/1000
-  **0,17**



NE

VE

RO

AZ

BL

NE

VIENNA BIRO CON FUSTO IN 7 COLORI

AL 2327 VIENNA

Penna sfera con fusto in plastica. Refil nero.

-  Plastica
-  50/1000
-  **0,17**



GI

AR

RO

BI

BL

VE



**AL 2276
ZURIGO**

Penna sfera in plastica con meccanismo a rotazione. Refil nero.

 Plastica

 50/1000

 0,39



**AL 2280
NEW CASTLE**

Penna a sfera in plastica con meccanismo a rotazione e finitura metallica. Refil blu.

 Plastica

 50/1000

 0,56

apertura a rotazione

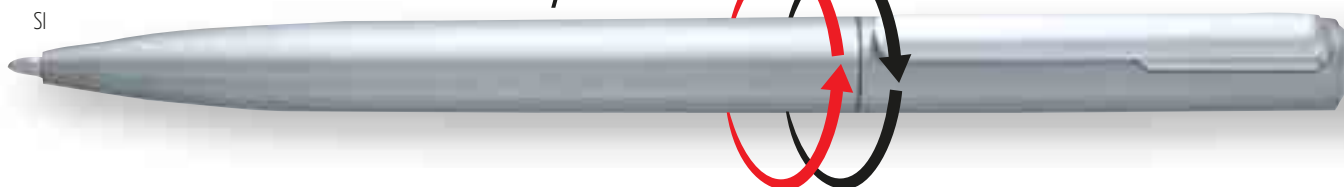

**AL 2320
CIPRO**

Penna sfera con fusto in plastica con finiture cromate. Refil nero.

-  Plastica
-  50/1000
-  0,38

PENNA IN PLASTICA

CON FINITURE CROMATE



PENNA IN ABS

CON FUSTO COLORATO

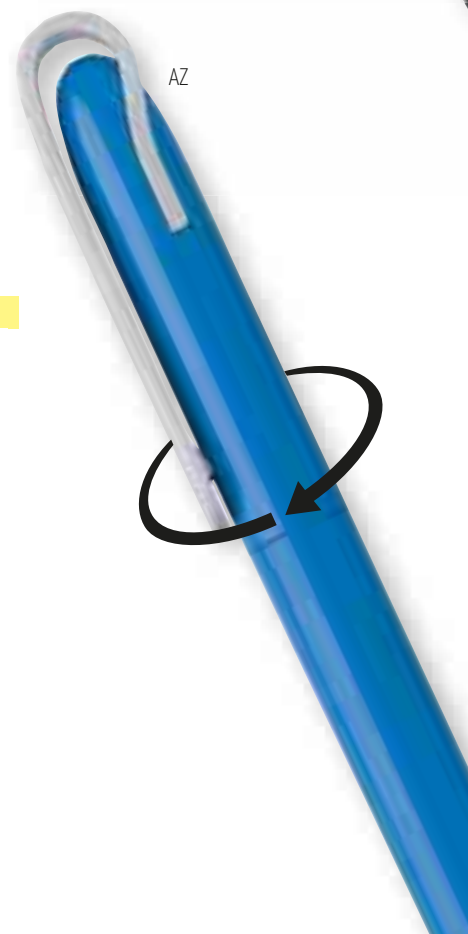
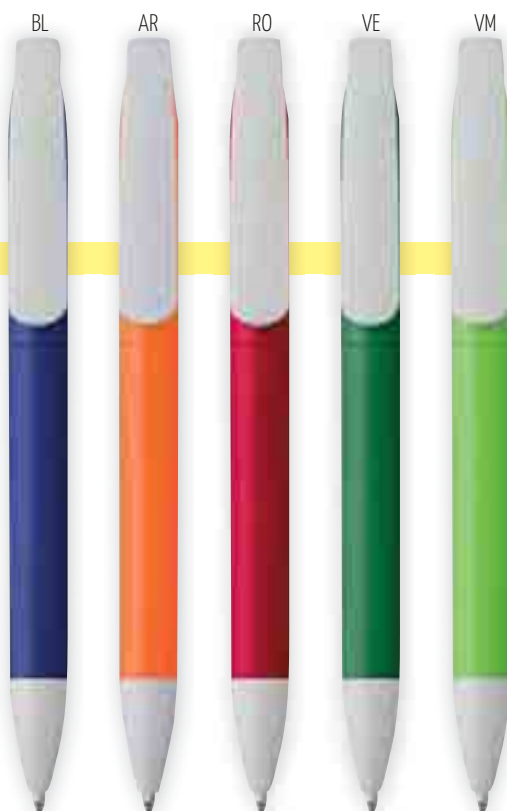
**AL 2305
FLORIDA**

Penna sfera in ABS colorato con finiture bianche. Refil blu.

-  Plastica
-  50/1000
-  0,26

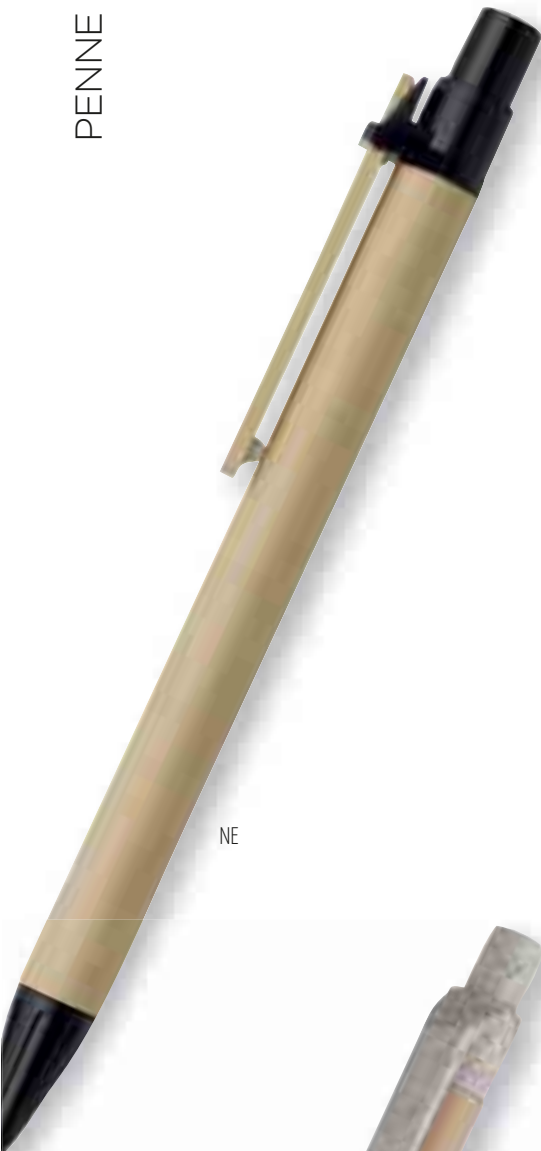

NE

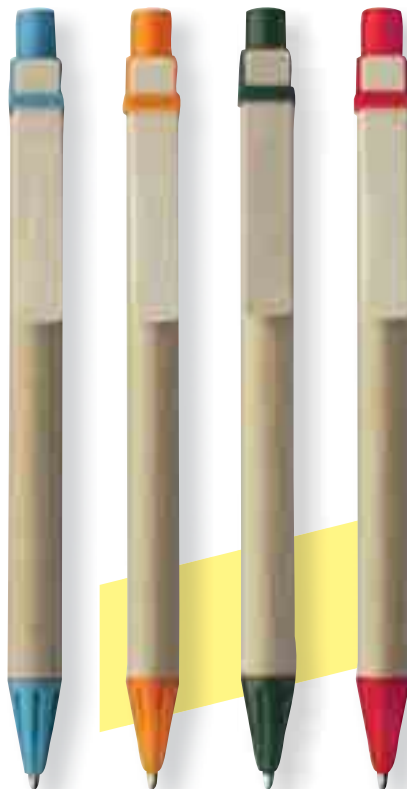

AZ

AR

VE

RO

**AL 2340
MADRID**

Penna a sfera in cartone biodegradabile, particolari in ABS, refill blu.

-  Cartone
-  50/1000
-  0,27

*in cartone
biodegradabile*

PENNE A SFERA

BI



RO

AR

AZ

VE

*in cartone
riciclato*

**AL 2342
SIVIGLIA**

Penna a sfera realizzata in cartone riciclato con particolari in fibra di grano e ABS. Refil blu.

-  Cartone
-  50/1000
-  0,33

**AL 2345
VALENCIA**

Penna a sfera in bamboo biodegradabile,
particolari in ABS, refill blu.

i Bamboo

♻️ 50/1000

€ 0,44

PENNA IN BAMBOO

biodegradabile



VE

AZ

BG

AR

RO



PENNA IN BAMBOO

con particolari in metallo

**AL 2347
BILBAO**

Penna a sfera in bamboo con particolari in
metallo. Refill blu

i Bamboo

♻️ 50/1000





€ 0,83



STILOFORI CON CORDINO A SPIRALE

AL 2368 STILOFORO

Con penna su base con piedini, cordino a spirale. Refil nero.

-  Plastica
-  16 x 6,5 cm - Ø 4 cm
-  50/200
-  **1,35**

AL 2370 STILOFORO

Con penna in plastica, cordino a spirale. Refil blu.

-  Plastica
-  16,3 x 5,4 x 4 cm
-  20/120
-  **1,14**







**AL 2373
PENNA DOCTOR**

Penna a sfera siringa con refill nero.

-  Plastica
-  13 cm - Ø 1 cm
-  50/1000
-  **0,45**

**AS 5064
PENNA LIPSTICK**

Penna in plastica a forma di rossetto. Refil blu.

-  Plastica
-  9,8x1,8 cm
-  100/500
-  **0,48**



PORTACHIAVI MINIPENNA TOUCH

**AL 2250
BERLINO**

Mini penna a sfera touch con portachiaavi in plastica refill nero.

-  Plastica
-  8 cm
-  50/1000
-  **0,63**

MATITE IN LEGNO MULTICOLOR



AL 2375 MATITA

Matita in legno colorato con gomma

i Legno

♻️ 100/2000

€ 0,12



MATITE IN LEGNO CON GOMMA COLORATA

AL 2378 MATITA

Matita in legno naturale con gomma

i Legno

♻️ 100/2000

€ 0,13

VE RO BL BI AR

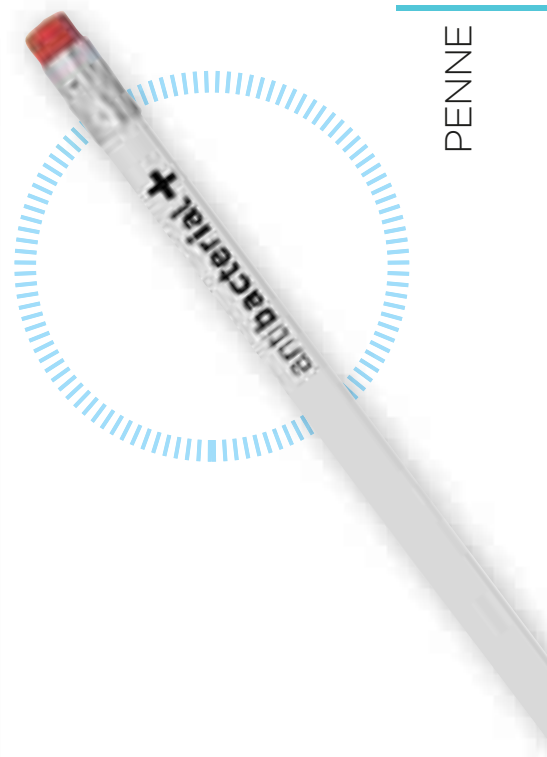

AL 2377 MATITA

Matita antibatterica bianca in legno non temperata con gomma. Logo antibatterico stampato sulla parte superiore della matita.

i Legno

♻️ 100/2000

€ 0,18



AL 2381 MATITA

ALL BLACK

i Legno

♻️ 50/1000

€ 0,27

AL 2382 MATITA

ALL BLACK con gomma

i Legno

♻️ 60/600

€ 0,33



AL 2376 MATITA

Matita con fusto nero e cristallino colorato in punta.

i Legno

♻️ 100/1000



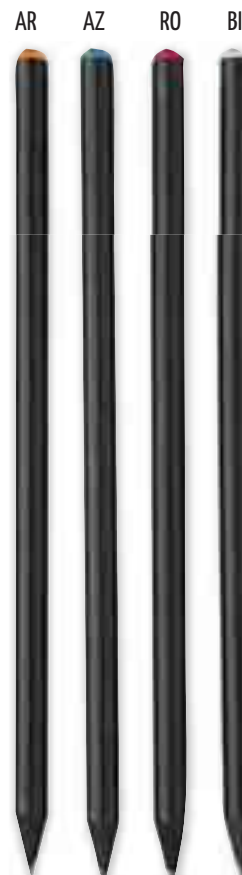

€ 0,39





AL 2506 SET 6 MATITE

Colorate, in astuccio cilindrico in cartone, coperchio in plastica con temperamatite.





-  Legno/ Carta
-  Ø 2,7 x 10,3 cm
-  48/480
-  **0,78**



GI

AL 2505 SET 12 MATITE

Colorate, in astuccio cilindrico in cartone, coperchio in plastica con temperamatite.





-  Legno/ Carta
-  Ø 3,5 x 10,7 cm
-  20/200
-  **1,17**



AZ

AL 2388 SET DISEGNO





Set 10 matite in legno con righello e temperamatite e con libricino da colorare.

-  Legno/ Carta
-  18 x 7,5x 1,2 cm
-  50/200
-  **1,77**



AL 2389 SET 6 MATITE

Set 6 matite corte colorate, confezione in cartoncino.

-  Legno/ Carta
-  4,5 x 9x 0,9 cm
-  48/960
-  **0,39**





AL 2410 SET ARTE

56 pezzi, pennarelli, acquarelli, matite, pastelli, temperamatite e gomma, in cofanetto.

i Plastica / Carta

1/12

€ 12,60



RO



AR



GI



BL



VE







NE



BI

AL 2424 ASTUCCIO

Astuccio portapenne con chiusura lampo.

-  Poliestere 420D
-  20,5 x 9,5 x 0,8 cm
-  50/200
-  **1,02**



ASTUCCIO PORTA PENNE

GOMMA CON TEMPERAMATITE



RO



BI







VE



BL

AL 2431 GOMMA

Gomma con temperamatite.

-  Plastica
-  6,4 x 3,4 x 1,7 cm
-  24/240
-  **0,81**



ACCENDINI

promosolution
2021|2022



AM 2515 ACCENDINO

Piezo in plastica, ricaricabile.

-  Plastica
-  8 x 2,4 cm
-  50/1000
-  **0,63**

Piezo

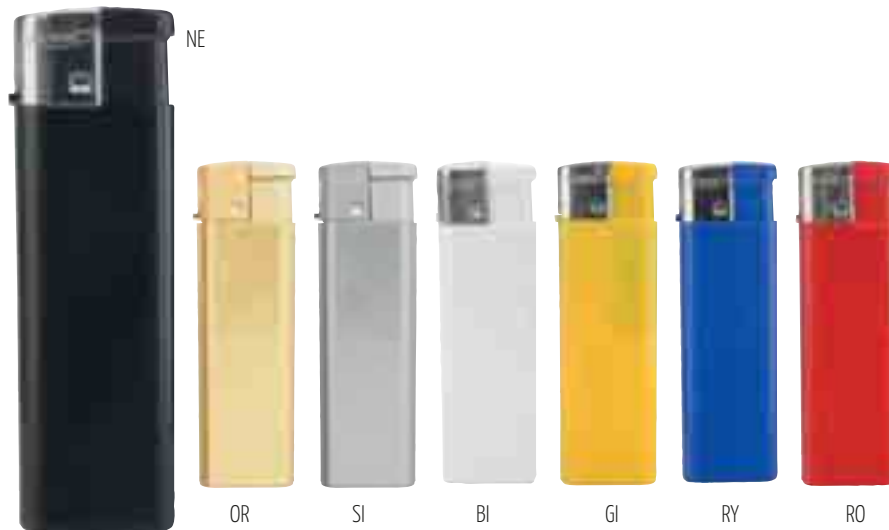

AM 2514 ACCENDINO

Piezo in plastica, ricaricabile.

-  Plastica
-  8 x 2,4 cm
-  50/1000
-  **0,51**

Ricaricabili

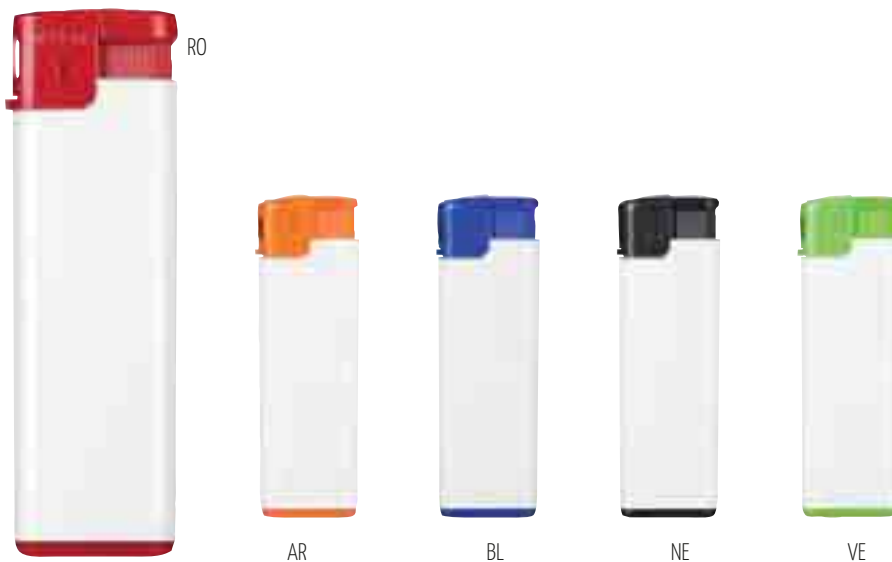

AM 2516 ACCENDINO

Piezo in plastica, ricaricabile.

-  Plastica
-  8 x 2,5 cm
-  50/1000
-  **0,51**

**AM 2518
ACCENDINO**

A pietra focaia in plastica neon. Confezione da 50 pz. in colori assortiti.

-  Plastica
-  8 x 2,3 cm
-  50/1000
-  **0,31**



CONFEZIONE
Con Colori Assortiti

**AM 2520
ACCENDINO**

A pietra focaia in plastica.

-  Plastica
-  8 x 2,4 cm
-  50/1000
-  **0,31**



ACCENSIONE
CON PIETRA FOCAIA

**AM 2519
ACCENDINO
APRIBOTTIGLIE**

In plastica a pietrina.

-  Plastica
-  9 x 2,4 cm
-  50/1000
-  **0,54**



con
Apribottiglie



**AM 2525
ACCENDINO**

Piezo in plastica, ricaricabile.

-  Plastica
-  6,4 x 3,5cm
-  30/300
-  **0,83**

**AM 2524
ACCENDINO**

Accendino in plastica ricaricabile.

-  Plastica
-  6,5 x 3,5 cm
-  30/600
-  **0,83**

*in Plastica
Ricaricabili**in plastica
Solid***AM 2526
ACCENDINO**

In plastica solid ricaricabile.

-  Plastica
-  8 x 3 cm
-  25/250
-  **0,94**

**AM 2527
ACCENDINO**

In plastica effetto gommato ricaricabile.

-  Plastica gommata
-  8 x 3 cm
-  25/250
-  **1,08**

*in plastica
Gommata*

**AM 2530
ACCENDINO**

In plastica solid FLUO ricaricabile. confezione da 25 pz. in colori assortiti.

-  Plastica Fluo
-  8 x 3 cm
-  25/250
-  1,03

**ACCENDINI
IN PLASTICA****FLUO****AM 2533
ACCENDINO**

In plastica FLUO effetto gommato ricaricabile. confezione da 25 pz. in colori assortiti.

-  Plastica Fluo gommata
-  9 x 2,4 cm
-  25/250
-  1,17

**ACCENDINI
IN PLASTICA
FLUO****Effetto Gommato**



BI



NE

**AM 2540
ACCENDIGAS**

In plastica ricaricabile.

-  Plastica
-  10,5 x 3,2 cm
-  28/280
-  **1,59**

Ricaricabili

RO



BI



GI

**AM 2523
ACCENDINO MAXI**





Piezo in plastica ricaricabile

-  Plastica
-  4 x 11 cm
-  20/100
-  **1,11**

Piezo MAXI





**AM 2552
ACCENDINO**

Tascabile con astuccio in cartoncino.

-  Metallo
-  5,6 x 3,6 cm
-  12/120
-  **2,34**

**ACCENDINI
TASCABILI****AM 2558
ACCENDINO**

Tascabile in metallo lucido con astuccio in cartoncino.

-  Metallo
-  5,6 x 3,6 cm
-  12/120
-  **2,55**

*Astuccio
in cartoncino***AM 2556
ACCENDINO**

Accendino in plastica con fiamma turbo antivento.

-  Plastica
-  6,6 x 4 x 1,9 cm
-  10/100
-  **2,88**

**FIAMMA
TURBO
ANTIVENTO**

POSACENERE TASCABILE CHIUSURA CON BOTTONE



AM 2565 POSACENERE TASCABILE

In PVC, Richiudibile con bottone.

-  PVC
-  8 x 8 cm
-  50/500
-  **0,87**



FX



VM



BL



SI

POSACENERE CERAMICA







NE



BI

AM 2569 POSACENERE IN CERAMICA

-  Ceramica
-  Ø 10,2 x H 3,3 cm
-  12/72
-  **2,67**



PORTACHIAVI

promosolution
2021|2022





AN 0102

Retro inciso con laser

PORTACHIAVI VIP

In metallo e caucciù con marchi auto pressofusi.

-  Metallo
-  2 x 2 cm
-  10/50
-  **2,53**

AN 0107



AN 0124

AN 0119



AN 0133

AN 0115



AN 0114

AN 0134



AN 0127

AN 0132

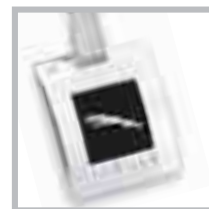

AN 0123

AN 0108



AN 0104

AN 0105



AN 0112

AN 0125



AN 0111

AN 0126



AN 0106

AN 0117



AN 0129

AN 0118



AN 0113

AN 0116

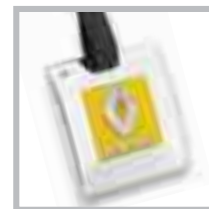

AN 0128

AN 0110



AN 0110

AN 0109



AN 0109

AN 0103



AN 0103

AN 0130



AN 0130

AN 0120



AN 0120

AN 0136

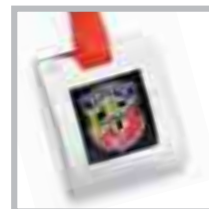

AN 0136

PORTACHIAVI VIP

In metallo con marchi auto pressofusi.

i Metallo 3,5 x 2 cm 10/50 2,53

AN 0148

Retro inciso con laser

AN 0156



AN 0140



AN 0141



AN 0167



AN 0151



AN 0168



AN 0145



AN 0150



AN 0162



AN 0174



AN 0169



AN 0153



AN 0155



AN 0173



AN 0161



AN 0152



AN 0142



AN 0143



AN 0154



AN 0164



AN 0147



AN 0163



AN 0159



AN 0158



AN 0144



AN 0166



AN 0160



AN 0165





AN 0157







**AN 2648
PORTACHIAVI VIP**

Rettangolare in metallo con superficie liscia per incisione laser.

-  Metallo
-  3,5 x 2 cm
-  50/200
-  € **1,85**





**AN 2632
PORTACHIAVI
RETTANGOLO**

In metallo a forma di rettangolo. Confezione in astuccio.

-  Metallo
-  4,5 x 2,5 cm
-  50/200
-  € **1,95**





**AN 2622
PORTACHIAVI CASA**

In metallo a forma di casa. Confezione in astuccio.

-  Metallo
-  7,1 x 4,8 cm
-  50/200
-  € **2,28**





**AN 2640
PORTACHIAVI
CERCHIO**

In metallo. Confezione In astuccio.

-  Metallo
-  Ø 3,2 cm - Ø interno 2,6 cm
-  50/200
-  € **1,83**





**AN 2623
PORTACHIAVI**

Portachiavi camion in metallo rivestito di nickel lucido.

-  Metallo
-  5,4 x 2,8 cm
-  50/200
-  € **2,04**





**AN 2624
PORTACHIAVI
AUTO**

In metallo a forma di auto. Confezione in astuccio.

-  Metallo
-  6,3 x 4,3 cm
-  50/200
-  € **1,83**

PORTACHIAVI *Tricolore*



AN 2868 PORTACHIAVI COAGULATO

-  Metallo
-  2 x 2,5 cm
-  50/200
-  € 2,94



AN 2710 PORTACHIAVI





In metallo e tessuto. Confezione in astuccio.

-  Metallo
-  2,2 x 4 cm
-  50/200
-  € 1,77



AN 2712 PORTACHIAVI

Portachiaavi rettangolare con placca in metallo colorata e fascetta in poliestere nero. Confezione in astuccio.

-  Metallo
-  4,1 x 2,5 cm
-  50/200
-  € 1,89

PORTACHIAVI IN METALLO

con fascette poliestere in Colori Assortiti





AN 2645 PORTACHIAVI 4 FUNZIONI

Apriporta in metallo, funzione portachiaavi, punta in gomma touch, gettone per la spesa.





-  Metallo
-  6,9 x 2,8 cm
dim. gettone Ø 2,5 cm
-  50/200
-  **1,98**

Touch



AN 2610 PORTACHIAVI GATTO





In metallo e lacca rossa, retro liscio per promo.
In astuccio.

-  Metallo
-  4 x 4 cm
-  50/200
-  **1,77**



AN 2602 PORTACHIAVI QUADRIFOGLIO





In metallo e lacca verde, retro liscio per promo.
In astuccio.

-  Metallo
-  3,5 x 4 cm
-  50/300
-  **1,98**







**AN 2771
PORTACHIAVI**

In legno con anello in metallo.

-  Legno e Metallo
-  5,3 x 3,8 x 0,8 cm
-  100/500
-  € 0,84

**AN 2772
PORTACHIAVI**

In legno con anello in metallo.

-  Legno e Metallo
-  Ø 3,8 x 0,8 cm
-  100/500
-  € 0,84





**AN 2773
PORTACHIAVI**

In legno con anello in metallo.

-  Legno e Metallo
-  5,5 x 3,4 x 0,8 cm
-  100/500
-  € 0,84

**AN 2760
PORTACHIAVI**

Portachiaivi in simipelle e metallo.

-  Simipelle
-  10 x 3,5 cm
-  50/200
-  € 1,17





con Gettone per carrello



AN 2831 PORTACHIAVI

Con luce e gettone per carrello, in plastica. Confezione in polybag.

-  ABS
-  3 x 7 x 0,7 cm
-  50/500
-  € 0,93







con luce led



AN 2832 PORTACHIAVI

Rettangolare con luce in plastica. Confezione in polybag.

-  ABS
-  2,5 x 6 x 0,7 cm
-  100/500
-  € 0,81







con luce led



AN 2833 PORTACHIAVI

Portachiaavi in ABS a forma di lampadina, anello in acciaio.

-  ABS
-  6 x 3,7 x 1 cm
-  100/500
-  € 0,87

**AL 2250
BERLINO**

Mini penna a sfera touch con portachiavi in plastica refill nero.





-  Plastica
-  8 cm
-  50/500
-  **0,63**



Touch

**AP 2992
PORTACHIAVI
TOUCH**

Portachiavi capacitivo compatibile su schermi touch, con luce LED bianca, batterie incluse.



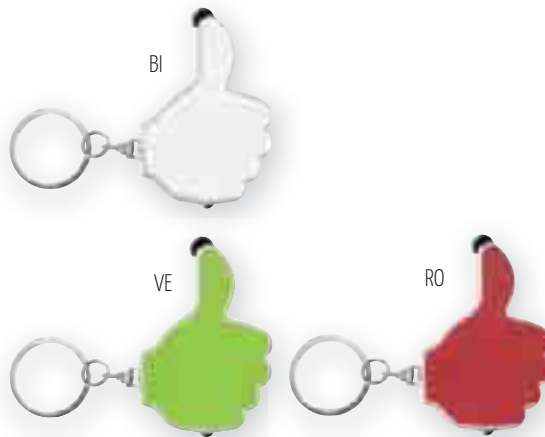

-  ABS
-  6,1 x 8,1 x 1,2 cm
-  100/500
-  **1,17**



Luce led

**AN 2836
PORTACHIAVI**

Portachiavi con il nastro di misurazione, livella, piccola penna a sfera refill nero.

-  ABS
-  4,3 x 4,3 x 1 cm
-  50/500
-  **0,54**



MULTIFUNZIONE



AN 2812 PORTACHIAVI T-SHIRT

In plastica trasparente con incastro etichetta per stampa promo. Fornito aperto.

-  Plastica
-  7,6 x 0,7 cm
-  100/500
-  **0,89**



AN 2817 REFIL

In carta per portachiavi, 12 pezzi prefustellati su foglio f.to A4

-  Carta
-  A4
-  12
-  **0,14 cad.**



AN 2813 PORTACHIAVI CERCHIO

in plastica trasparente con incastro etichetta per stampa promo. Fornito aperto.

-  Plastica
-  Ø 4,5 x 0,7 cm
-  100/200
-  **0,83**



AN 2815 REFIL

In carta per portachiavi, 12 pezzi prefustellati su foglio f.to A4

-  Carta
-  A4
-  12
-  **0,14 cad.**



AN 2814 PORTACHIAVI RETTANGOLO

in plastica trasparente con incastro etichetta per stampa promo. Fornito aperto.

-  Plastica
-  9 x 4,2 x 0,6 cm
-  100/500
-  **0,73**







AN 2816 REFIL

In carta per portachiavi, 12 pezzi prefustellati su foglio f.to A4

-  Carta
-  A4
-  12
-  **0,14 cad.**





AN 2841 PORTACHIAVI T-SHIRT

a forma di t-shirt in EVA.

-  EVA
-  6 x 6,2 x 1,1 cm
-  250/1000
-  **0,54**

AN 2842 PORTACHIAVI RETTANGOLO



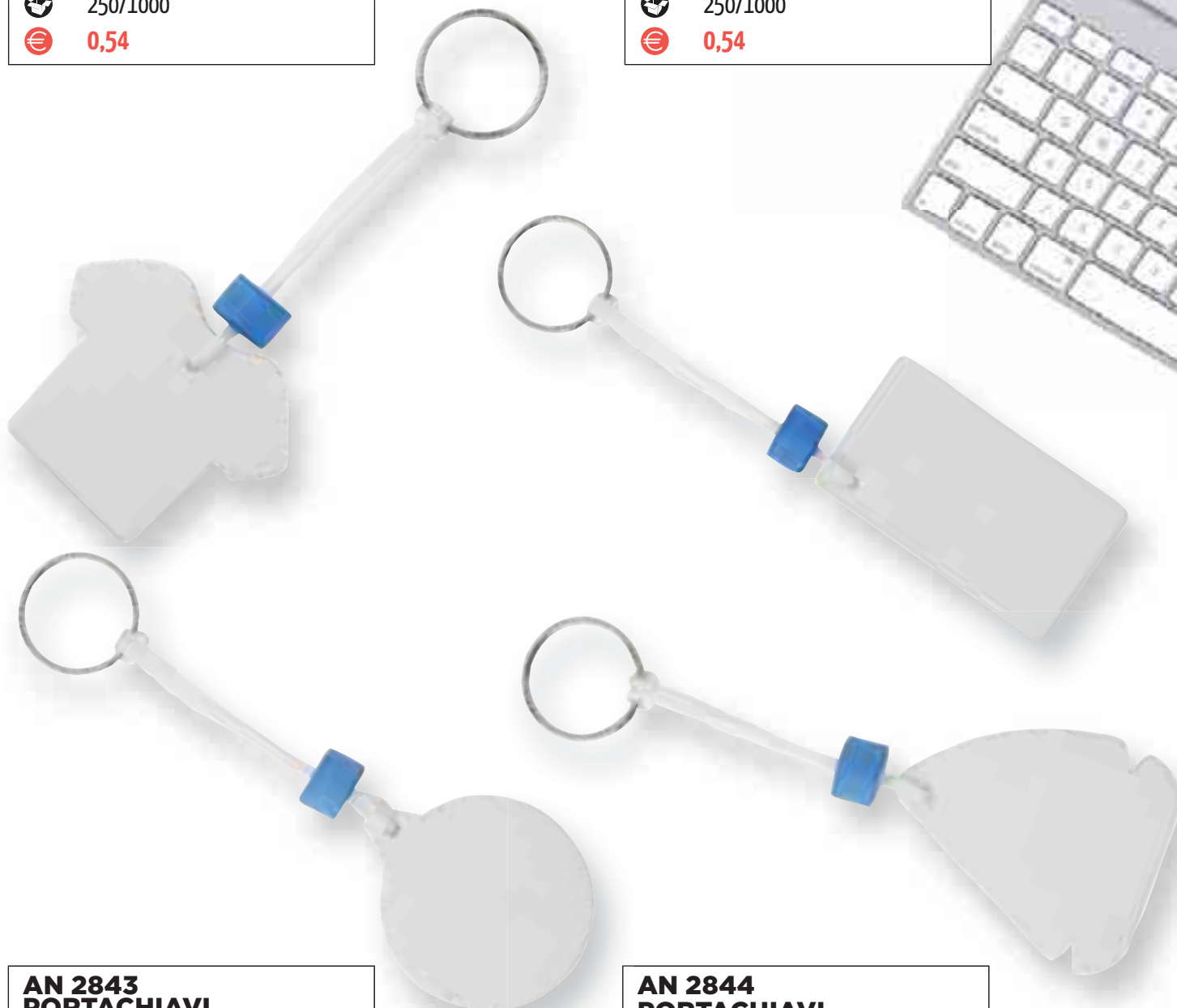

a forma di rettangolo in EVA.

-  EVA
-  7 x 4 x 1,1 cm
-  250/1000
-  **0,54**







AN 2843 PORTACHIAVI CERCHIO

a forma tonda in EVA.

-  EVA
-  Ø 5 x 1,1 cm
-  250/1000
-  **0,54**





AN 2844 PORTACHIAVI VELA

a forma di barca a vela in EVA.

-  EVA
-  7 x 5,5 x 1,1 cm
-  250/1000
-  **0,54**

**AN 2845
LANYARD**

Collarino in poliestere con sgancio di sicurezza, sgancio portachiaavi e moschettone in metallo.





-  Poliestere
-  55 x 2,5 cm
-  50/500
-  **0,87**



LANYARD IN POLIESTERE CON SGANCIO DI SICUREZZA





**AN 2850
LANYARD**

Collarino in poliestere con sgancio di sicurezza, sgancio portachiaavi e moschettone in metallo.

-  Poliestere
-  55 x 2 cm
-  50/500
-  **0,87**

**AN 2851
LANYARD**

Collarino in fibra di bamboo, clip e sgancio di sicurezza in fibra di grano, moschettone in metallo.





-  Fibra di bamboo
-  50 x 2,5 cm
-  50/500
-  **1,77**

**LANYARD**

IN TESSUTO DI BAMBOO E FIBRA DI GRANO

**AN 2852
LANYARD**

Lanyard in materiale RPET proveniente da bottiglie riciclate, con moschettone in metallo.

-  RPET
-  50 x 2 cm
-  100/800
-  **0,84**

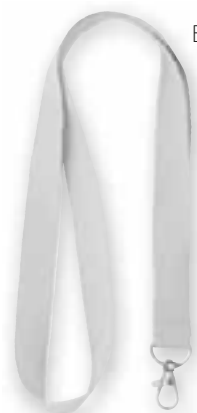
**LANYARD**

TESSUTO RICAVATO DA RICICLO PLASTICA



RO









RO

AN 2846 LANYARD

Con portabadge in pvc incluso.

-  Poliestere/PVC
-  Portabadge: 9,5x5,4 cm
Lanyard: 47 cm
-  50/500
-  **1,12**







NE







BL

AN 2848 PORTABADGE

-  PVC trasparente
-  11,3 x 9,5 cm (10x7 int.)
-  10/100
-  **0,39**

AN 2849 PORTABADGE

-  PVC trasparente
-  8,2 x 13 cm (11x7,5 int.)
-  10/100
-  **0,37**







HI-TEC

promosolution
2021|2022



AB 0385 AURICOLARI

Auricolari di ultima generazione della collezione Gear Matrix di Hugo Boss, 6 ore di carica con Case da ricarica 28 ore. Chipset di ultima generazione "ultra clear sound" JL2697. Funzionalità haptic touch per rispondere/interrompere telefonate direttamente dall'auricolare e funzione di start/stop della musica. Ricarica USB-C o ricarica wireless con Qi technology. Funzione di noise cancellation. Doppio microfono per ogni auricolare. Confezionato in scatola regalo Hugo Boss.

-  ABS
-  6,8x2,2x4,5 cm
-  1

HUGO BOSS

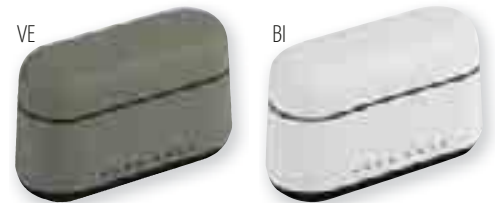





AURICOLARI WIRELESS BLUETOOTH CON CUSTODIA





AP 2927 AURICOLARI WIRELESS

Auricolari wireless Bluetooth 5.0 con custodia di ricarica. Elegante finitura bianco lucido. Pannello di controllo con tecnologia touch integrata nell'auricolare. Funzione vivavoce. Custodia con batteria ricaricabile e coperchio magnetizzato. Cavo incluso. Fornito in astuccio.

-  ABS
-  6,8 x 2,2 x 4,5 cm
-  1/50
-  23,70

AP 2934 AURICOLARI WIRELESS





Auricolari wireless, funzione di risposta alle chiamate, lunghezza cavo 51 cm circa, ricarica tramite USB, moschettone, in comodo astuccio.

-  ABS
-  10 x 3 x 3 cm
-  10/100
-  € 7,50



AP 2928 AURICOLARI





Auricolari con supporto per tablet e smartphone, in plastica ed in tinta colore, lunghezza cavo 108 cm circa.

-  ABS
-  9 x 4 cm
-  10/80
-  € 1,77



AP 2931 AURICOLARI

Auricolari colorati, lunghezza cavo circa 103 cm, custodia ovale in ABS in tinta colore.

-  ABS
-  7,2 x 2,4 x 1,3 cm
-  10/500
-  € 1,08

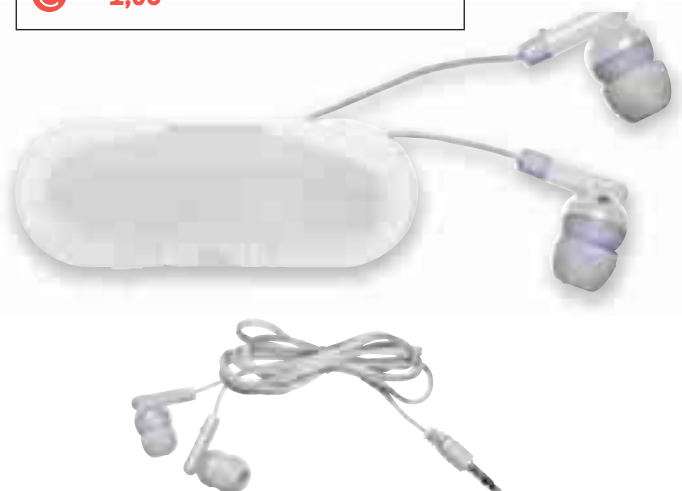

AP 2929 AURICOLARI IN-EAR MUSIC

Auricolari con presa da 3,5 mm, cavo lungo ca. 117 cm, in custodia dal colore abbinato.



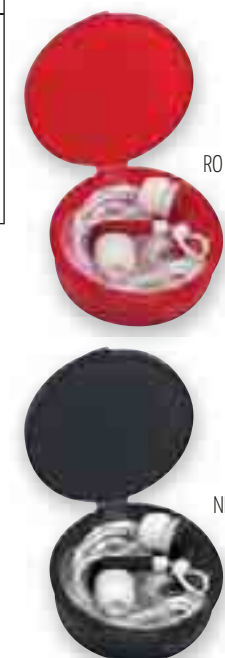

-  Plastica
-  Ø 5,4 x 2,1 cm
-  10/100
-  € 1,56





AP 2905 SPEAKER WIRELESS

Speaker wireless vintage, uscita 4A3 W, rapporto > 75 db D80mm (120 Hz-18 kHz), ingresso DC 5V, Micro SD slot, durata ricarica batteria 1,5 ore a volume alto, 10 ore a volume basso, rivestimento gommato, cinturino.

-  ABS
-  10,8 x 3,9 x 5,2 cm
-  1/30
-  **11,70**







SPEAKER BLUETOOTH







AP 2924 SPEAKER WIRELESS

Altoparlante bluetooth potenza musicale 3 watt, con versione Bluetooth 4.1, slot per schede micro-SD, incluso cavo di ricarica (da USB a mini-USB e 3,5 mm connettore line-in), riproduce MP3, con funzione vivavoce, batteria ricaricabile integrata con 450 mAh, tempo d'uso: circa 5 ore, tempo di ricarica: circa 2 ore, raggio d'azione circa 10 m, fondo gommato per una presa sicura.

-  ABS/ Metallo/ Gomma
-  Ø 5,8 x 5 cm
-  1/50
-  **11,85**

AP 2906 CASSE SPEAKER

Casse speaker in ABS, forma rotonda, finitura opaca, con cavo per smartphones/tablets.

-  ABS
-  Ø 7,5 cm - Vol. 0,813 cdm³
-  1/50
-  **6,75**

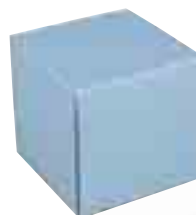





**AP 2979
POWERBANK**

Powerbank con batteria d'emergenza a litio, capacità di 4.000mAh, input 5v/1A, output 5v/1A, indicatore di ricarica, include porta USB, micro USB.

-  Alluminio
-  11 x 6,8 x 1 cm
-  1/25
-  **14,25**





**AP 2968
POWERBANK**

Powerbank adatto per i più comuni smartphone e apparecchi USB, cavo di ricarica USB con micro presa USB (lungo ca. 30 cm), potenza in entrata e uscita: 5V/ 1 A, capacità: 4.000 mAh, potente batteria ricaricabile.

-  ABS
-  9,7 x 4,5 x 2,3 cm
-  1/25
-  **11,70**





**AP 2977
POWERBANK**

Powerbank con una capacità di 5000mAh, un ingresso di 5V/1A e uscita di 1A/2.1A/5V. Entrambi i lati sono lucidi con un bordo color argento. Include 5 luci di indicazione di alimentazione di LED blue e un cavo USB/micro USB bianco (circa 32 cm.), batteria agli ioni di litio ad alte prestazioni.

-  ABS
-  12,2 x 7,2 x 1,1 cm
-  1/25
-  **28,50**

**AP 2975
POWERBANK**

Power bank in ABS da 5000 mAh. Uscita di corrente DC5V/2.1A. Schermo digitale con indice di caricamento. Finitura al tatto gomma con luce LED interno ideale per la stampa laser. Cavo Micro USB incluso. Confezione in astuccio.

-  ABS
-  9,4x6,2x1,3 cm
-  1/25
-  **22,50**



NE







BI







**AP 2972
POWERBANK WIRELESS**

Base di ricarica wireless per smartphone. La ricarica avviene collegando il dispositivo ad una porta usb e posizionando lo smartphone sulla superficie. Compatibile con modelli con tecnologia di ricarica wireless. DC5V / 1.0A. Cavo incluso. Fornito in astuccio.

-  ABS
-  Ø7 x 1 cm
-  1/50
-  **5,97**

**AP 2980
SPEAKER BLUETOOTH**

Con funzione ricarica wireless in ABS retroilluminato, potenza altoparlante 3W Uscita wireless DC5V. Ricarica lo smartphone mentre ascolti la tua musica preferita. Include Cavo incluso micro usb. Confezione in astuccio.





-  ABS
-  h.4 x Ø6,5 cm
-  1/50
-  **26,85**



POWERBANK E CARICA BATTERIE PER AUTO

**AP 2936
CARICABATTERIE
PER AUTO**

Con ingresso USB, input 12-24V, output 5V/800mAh.

-  ABS / Metallo
-  5,5 x 2,4 cm
-  100/600
-  **1,26**

**AP 2967
POWERBANK**



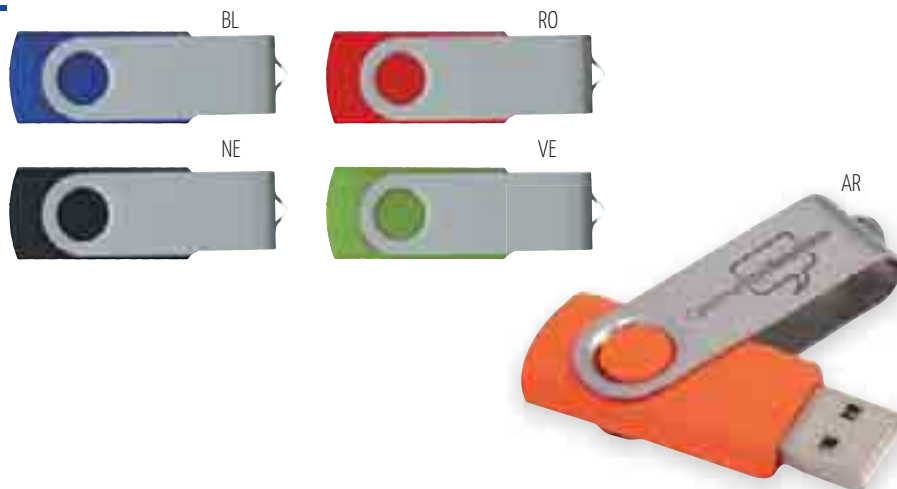

Adatto per smartphone, iPhone ed apparecchi USB, incl. cavo USB con presa USB micro (lungo: ca. 25 cm), ingresso alimentazione: 5V, potenza in uscita: 5V/ 1000 mA, tempo di ricarica: circa 4 ore, capacità: 2200 mAh, batteria agli ioni di litio ad alte prestazioni. Cavo non incluso.

-  Plastica ABS
-  9,8 x 2,4 x 2,1 cm
-  8/80
-  **4,47**



**AP 2988
16 GB USB**
**AP 2989
8 GB USB**





Pendrive Rotate da 8 GB. Maggiore protezione grazie al meccanismo girevole. Laccetto e astuccio inclusi.

-  ABS / Metallo
-  5,5 x 1,5 x 1 cm
-  1/50
-  € 9,45 (8gb)  € 11,85 (16gb)

PENDRIVE 8 e 16 GB

**AP 2993
16 GB USB**



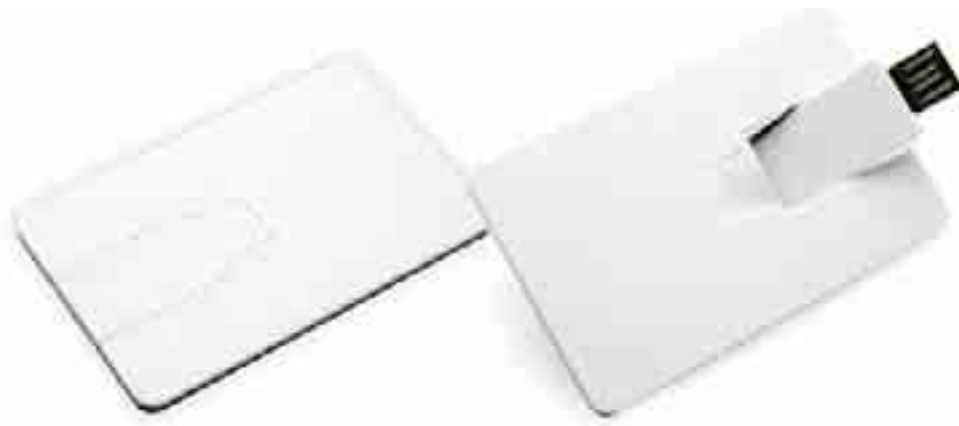

Pendrive Portachiaavi USB in metallo e pelle con chiusura magnetica.

-  Pelle/ Metallo
-  16 x 10,4 x 3,2 cm
-  1/50
-  € 18,90

PENDRIVE CARD 8 GB

**AP 2994
8 GB USB**





Card in pvc con Pendrive USB ripiegabile, adatta per stampa UV.

-  PVC
-  8,5 x 5,5 cm
-  1/50
-  € 11,94



AP 3000 SUPPORTO PER CELLULARE

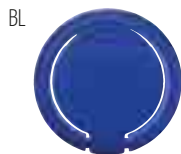

Supporto per cellulare multifunzione. Anello girevole a 360°. Moneta trolley integrata. Adesivo.

-  ABS
-  0,6 x Ø3,3 cm
-  200/1000
-  **0,63**



AP 2992 PORTACHIAVI TOUCH CAPACITIVO



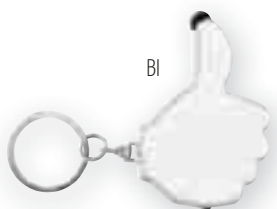

Portachiavi capacitivo compatibile su schermi touch, con luce LED bianca, batterie incluse.

-  ABS
-  6,1 x 8,1 x 1,2 cm
-  100/500
-  **1,17**



AN 2895 BRACCIALETTA

Braccialetto in silicone con USB, utilizzabile per la ricarica di vari device in commercio tramite la micro USB, placca in metallo per la personalizzazione.

-  PVC
-  22 x 1,3 x 0,8 cm
-  1/50
-  **2,25**



TIME & OFFICE

promosolution
2021|2022

OROLOGIO DA PARETE

confezionato in astuccio



BL

Numeri in 3D



RO



BI

AP 3078 OROLOGIO DA PARETE

Orologio in plastica con numeri in 3D. Confezione in astuccio.

-  Plastica/Vetro
-  Ø 30,3 x 4,8 cm
-  10
-  **15,90**

AP 3076**OROLOGIO DA PARETE**

Orologio in plastica con cornice facilmente removibile.

-  Plastica/Vetro
-  Ø 29x5,5 cm
-  10
-  **11,94**



OROLOGI DA PARETE

con cornice removibile

FUNZIONE TEMPERATURA E UMIDITÀ

AP 3077**OROLOGIO DA PARETE**

Orologio con cornice in alluminio facilmente removibile. Quadrante con funzione temperatura e umidità.

-  Plastica/Vetro
-  Ø 30 x 2cm
-  10
-  **14,94**









OROLOGIO DA PARETE CON FUNZIONI DI IGROMETRO E TERMOMETRO

AP 3080 OROLOGIO DA PARETE

Orologio da parete multifunzione. Funzioni di orologio, igrometro e termometro.

-  Plastica/Vetro
-  27,5 x 32x 2,7 cm
-  10
-  **12,45**

OROLOGIO DA PARETE



BL







SI

CON DOPPIO
QUADRANTE
ESTRAIBILE

AP 3079 OROLOGIO DA PARETE

Orologio rettangolare con doppio quadrante estraibile per facile personalizzazione. Confezione in astuccio.

-  Plastica
-  23 x 33 cm
-  10/50
-  **10,05**



PORTA PENNE IN ABS

AP 3071 PORTAPENNE

Portapenne in plastica bianca.

	ABS
	8,2 x 8,2 x 10,2 cm
	10/50
	5,37

AP 3070 PORTAPENNE

Portapenne da tavolo con orologio, funzione sveglia, calendario e termometro, batterie incluse.

	ABS/ Acrilico/ LCD
	5,5 x 10,5 x 12 cm
	10/40
	8,34

PORTA PENNE CON OROLOGIO SVEGLIA e TERMOMETRO



PORTA PENNE CON PERSONALIZZAZIONE AD INCASTRO

AP 3072 PORTAPENNE

Portapenne in plastica bianca con copertura trasparente ad incastro adatta a contenere foglio bianco per la personalizzazione.

	ABS
	8,2 x 8,2 x 10,2 cm
	10/50
	5,37





**AL 2370
STILOFORO**

Con penna in plastica, cordino a spirale. Refil blu.

-  Plastica
-  16,3x5,4x4 cm
-  20/120
-  **1,14**





**AP 3002
PORTAPENNA/
SMARTPHONE**

Supporto portapenna/smartphone magnetico in ABS, include penna a sfera refil blu. Fornito in confezione regalo.

-  ABS
-  14,5 x 8,8 x 1,5 cm
-  10/50
-  **5,67**

**AP 3005
PORTAPENNE**

Portapenne in plastica con luce led e supporto porta cellulare.





-  ABS
-  6,7 x 6,7 x 8 cm
-  1/20
-  **7,05**





AP 3044 TAPPETINO MOUSE





Stampa sublimatica.

-  Poliestere/ Silicone
-  19 x 23 cm
-  1/20
-  **1,77**

TAPPETINO MOUSE
PER SUBLIMAZIONE

AP 3053 DISPENSER

Dispenser nastro adesivo. In ABS. Scotch incluso. Completa di astuccio.

-  ABS
-  13 x 7,1 x 5,4 cm
-  10/40
-  **1,47**

DISPENSER
NASTRO
ADESIVO

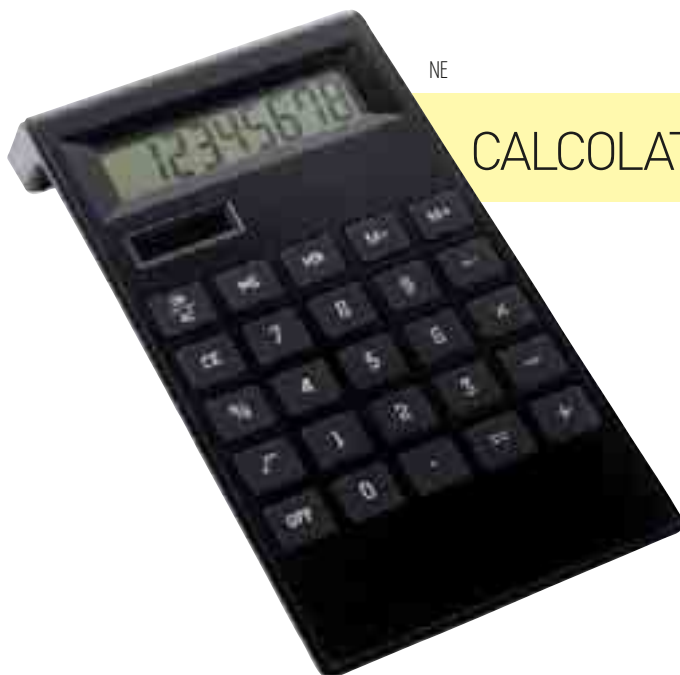





NE

CALCOLATRICE 8 CIFRE

AP 3004 CALCOLATRICE

Calcolatrice 8 cifre, alimentazione a batteria e solare. Batteria inclusa.

-  ABS/ LCD/ Vetro
-  19,5 x 10,5 x 3,7 cm
-  1/25
-  **8,67**



SI



BI



SHOPPER





promosolution
2021|2022

SHOPPER IN COTONE

Con Manici Colorati

AQ 4036 SHOPPER COTTON 38x42x8

Shopper in cotone naturale con soffiETTO e manici lunghi colorati.

-  Cotone - 180 gr/mq
-  38 x 42 x 8 cm
-  50/200
-  2,28



SHOPPER IN COTONE

Con Manici Colorati



AR



RO

NE



RO



BL



VE



**AQ 4033
SHOPPER COTTON
38x42**

Shopper in cotone naturale con manici lunghi colorati.



Cotone - 135 gr/mq



38 x 42 cm







50/200







1,59

**AQ 4031
SHOPPER COTTON
38x42**Borsa in cotone con Manici
Lunghi(cm.1,5x60).





-  Cotone - 130 gr/mq
-  38 x 42 cm
-  50/250
-  **1,32**

**AQ 4032
SHOPPER COTTON
38x42**Borsa in cotone con Manici
Lunghi(cm.1,5x60).

-  Cotone - 180 gr/mq
-  38 x 42 cm
-  40/200
-  **1,62**

**AQ 4021
SHOPPER COTTON
38x42**

Borsa in cotone con Manici corti.

-  Cotone - 130 gr/mq
-  38 x 42 cm
-  50/200
-  **1,26**

SHOPPER IN COTONE

con manici in tinta







SHOPPER IN COTONE

con manici lunghi

AQ 4020 SHOPPER COTTON 38x42

Borsa da shopping in cotone.
Manici Lunghi (cm.1,5x60).

-  Cotone - 135 gr/mq
-  38 x 42 cm
-  50/200
-  **1,62**







SHOPPER IN TNT

con manici lunghi



AQ 4022 SHOPPER TNT 45x37

Borsa da Shopping con manici lunghi.

-  TNT - 80 gr/mq
-  45 x 37 cm
-  100/300
-  **0,96**





FX

SHOPPER IN COTONE

con manici lunghi

AQ 4023 SHOPPER TNT 38x42

Borsa da Shopping con manici lunghi.

-  TNT - 80 gr/mq
-  38 x 42 cm
-  20/200
-  **0,63**



SHOPPER IN TNT

con manici lunghi

AQ 4025 SHOPPER TNT 38x40x10

Shopper in tnt con due manici lunghi.

 TNT - 80 gr/mq

 38 x 40 x 10 cm

 20/200

 **0,99**

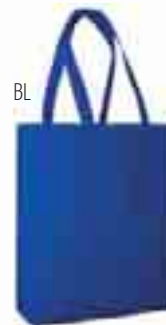





SHOPPER IN TNT

con manici corti

AQ 4030 SHOPPER TNT 45x42x15

Borsa da shopping con soffietto.

-  TNT - 80 gr/mq
-  45 x 42 x 15 cm
-  20/200
-  **1,29**

SHOPPER







SHOPPER IN TNT

Bicolore

AQ 4010 SHOPPER TNT 38x42x10

Borsa da shopping bicolore con soffietto.
Materiale: tessuto non tessuto.

-  TNT - 80 gr/mq
-  38 x 42 x 10 cm
-  50/200
-  € **1,68**









SHOPPER IN TNT RICHIUDIBILE

AQ 4035 SHOPPER TNT 30x40x20

Borsa da shopping in Tnt
richiudibile. Chiusura con bottone.

-  TNT - 80 gr/mq
-  30 x 40 x 20 cm
-  25/100
-  **2,25**



RY

BI



RO



AR



VE



RICHIUDIBILE



GI







**SHOPPER
IN TNT
RICHIUDIBILE
CON
BOTTONE**



**AQ 4026
SHOPPER TNT
40x47,5**

Borsa da shopping in TNT richiudibile.
Chiusura con bottone.

-  TNT - 80 gr/mq
-  40 x 47,5 cm
-  50/150
-  **1,35**

AQ 4005 SHOPPER TNT 40x50

Shopper in tnt richiudibile con coulisse,
doppio manico, doppia tasca esterna.

i TNT - 80 gr/mq

o 40 x 50 cm

u 10/120

€ 1,26

LV



GI



AR



RO



BI



BG



SHOPPER IN TNT

con doppia tasca esterna



**AQ 4016
SHOPPER TNT
32x25**

Borsa in tnt goffrato con soffietto.

-  TNT Goffrato - 100 gr/mq
-  32 x 25 x 25 cm
-  10/100
-  € **0,99**

**AQ 4019
SHOPPER TNT
21x25**

Shopper in tnt con doppio manico.

-  TNT Goffrato - 100 gr/mq
-  21 x 25 cm
-  50/300
-  € **0,57**





VE



AR



BG



FX



**AQ 4018
SHOPPER TNT
50x40**

Borsa in tnt gofrato con soffietto.

-  TNT Gofrato - 100 gr/mq
-  50 x 40 x 22 cm
-  12/120
-  **0,96**

**AQ 4042
SHOPPER TNT
RESISTANT 38x42**

Effetto striato

i TNT - 100 gr/mq

o 38 x 42 cm

♻️ 10/200

€ 0,69

**AQ 4012
SHOPPER TNT
45x35**

Borsa in tnt gofrato.

i TNT - 100 gr/mq

o 45 x 35 cm

♻️ 10/300

€ 0,69

BI



GR



NE







BL





**AQ 4043
MAXI SHOPPER
TNT RESISTANT
50x38x15**

Effetto striato





-  TNT - 100gr/mq
-  50x38x15 cm
-  10/100
-  **1,17**

SHOPPER IN TNT RESISTANT







**AQ 4054
SHOPPER IN PPL
25x18x10**

Shopper in tnt con due manici lunghi.

-  PPL
-  25 x 18 x 10 cm
-  10/100
-  **0,69**

**AQ 4055
SHOPPER IN PPL
52x37x20**

Shopper in polipropilene con doppio manico lungo, richiudibile con velcro.

-  PPL
-  52 x 37 x 20 cm
-  20/120
-  **3,57**



**RICHIUDIBILE
CON VELCRO**

SHOPPER IN POLIPROPILENE

BI







NE



AQ 4040
SHOPPER IN TNT
LAMINATO 38x36

Borsa Shopper in TNT laminato con
 due manici lunghi.

-  TNT - Laminato
-  38 x 36 cm
-  10/100
-  **0,78**





SHOPPER IN TNT LAMINATO

*con manici
 lunghi*



**AQ 4051
SHOPPER IN PPL
45x35x14**





Borsa shopping in polipropilene
chiusura con zip.

-  PPL
-  45 x 35 x 14 cm
-  50
-  **1,98**



**AQ 4052
SHOPPER IN PPL
35x25x15**

Borsa shopping in polipropilene
chiusura con zip.

-  PPL
-  35 x 25 x 15 cm
-  50
-  **1,47**

SHOPPER IN PPL
con zip di chiusura



VI







VI



SI

AQ 4045
SHOPPER IN PPL
35x35x20

Borsa da shopping in Polipropilene.
 chiusura con bottoncino.

-  PPL
-  35 x 35 x 20 cm
-  50/100
-  **2,67**





SHOPPER IN PPL

chiusura con bottoncino







**AR 4060
PORTABICCHIERE**

Portabicchiere da degustazione.

-  TNT
-  22 x 18 cm
-  50/200
-  **0,48**





**AR 4061
PORTABOTTIGLIE**

Borsa portabottiglia in tnt termosaldata, con soffietto alla base e manici fustellati.

-  TNT
-  17 x 40 x 10 cm
-  100/600
-  **0,36**





**AR 4062
SHOPPER
PORTABOTTIGLIA**

in tnt con doppio manico.

-  TNT - 80 gr/mq
-  10x33x10 cm
-  100/500
-  **0,87**

**AQ 4056
BORSA WINE
37x21x10,5**

Borsa porta 4 bottiglie in polipropilene.

-  Polipropilene
-  37 x 21 x 10,5 cm
-  10/100
-  **1,17**

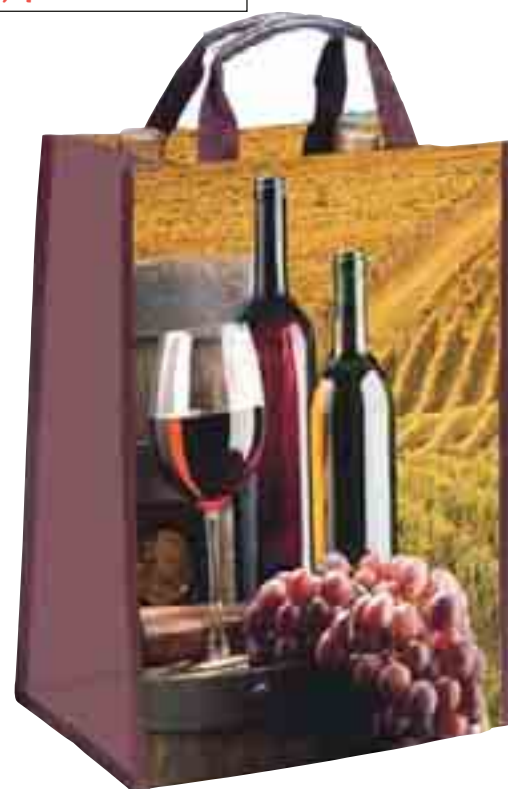



WINE & HOME

promosolution
2021|2022

**AR 4120
TAZZA**

Tazza bianca con trattamento per sublimazione, astuccio incluso. **Capacità 325 ml.**

-  Ceramica
-  Ø 8,1 x H 9,5 cm
-  36/144
-  **2,67**



trattamento per sublimazione



RO

NE



BL

**AR 4121
TAZZA**

Tazza bianca con bordo e manico colorati. Astuccio incluso. **Capacità 300 ml.**

-  Ceramica
-  Ø 8,2 x H 9,5 cm
-  36/144
-  **3,15**



FX

IN CERAMICA
FLUORESCENTE
PER
SUBLIMAZIONE
O LASER

**AR 4122
TAZZA FLUO**

in ceramica fluorescente personalizzabile in sublimazione o con incisione laser. **Capacità 325 ml.**

-  Ceramica
-  Ø 8,1 x H 9,5 cm
-  36/144
-  **3,57**



VE







GI



AR

AR 4114
TAZZA
BIODEGRADABILE



in fibra di grano, leggera. Capacità 300 ml

-  Fibra di grano
-  Ø 8,4 x 9,5 cm
-  36/144
-  **2,19**



AR 4115
BICCHIERE

Bicchieri in fibra di riso e PP.
Capacità 400 ml.

-  Fibra di riso e PP
-  Ø88 x 102 mm
-  50/200
-  **1,95**

BI



AZ



VE



GI



AR 4113
BICCHIERE
BIODEGRADABILE





in carta con interno in PLA. Capacità 500 ml

-  Carta e PLA
-  Ø 8,9 x 13,4 cm
-  50/500
-  **0,57**



**AR 4130
CONTENITORE CIBO**

Contenitore cibo ermetico in PP con 3 scomparti (250 ml, 270 ml e 470 ml). Forchetta e coltello incluse. Adatto per microonde (rimuovere il coperchio).

-  Polipropilene
-  23,5 x 19,5 x 6 cm
-  5/60
-  **3,99**

adatto a microonde







CONTENITORE ERMETICO 3 SCOMPARTI

CONTENITORE CIBO CON POSATE

biodegradabile

**AR 4132
LUNCH BOX**

Contenitore cibo con coltello e forchetta in paglia di grano biodegradabile. **Capacità 500 ml.**

-  Paglia di grano
-  16,5 x 11,3 x 4,4 cm
-  10/50
-  **5,55**







**AY 7745
BICCHIERE**

Bicchiere in plastica telescopico, custodia con moschettone. Capacità 220 ml.

-  Ceramica
-  Ø 8,3 x H 9,7 cm
-  36/144
-  1,98

**CUSTODIA CON
MOSCHETTONE****AR 4133
SET 8 CANNUCCE**

In cartoncino bianco biodegradabile





-  Cartoncino Biodegradabile
-  25x3,2 cm (astuccio)
-  100/500
-  0,57



biodegradabili

**AR 4134
SET 3 POSATE**

In paglia di grano biodegradabile composto da cucchiaio, forchetta e coltello in astuccio.

-  Paglia di grano biodegradabile
-  20 x 6 x 2,5 cm
-  50/200
-  2,37





TAGLIA PIZZA INOX

AR 4086 TAGLIAPIZZA





Taglia pizza in acciaio inossidabile con server in acciaio inossidabile, robusta maniglia in plastica.

-  Acciaio e Plastica
-  28,7 x 11 x 1 cm
-  40/160
-  **5,70**



AR 4088 TAGLIAPIZZA

Tagliapizza con apribottiglia in plastica e metallo.

-  Polipropilene
-  13 x 6 cm
-  5/60
-  **1,35**



con apribottiglia



AR 4073 SOTTOBICCHIERE

Sottobicchiere/bottiglia in plastica ed acciaio, con apribottiglie incorporato, fondo antiscivolo.

-  Plastica e Acciaio
-  8,2 x 8,2 cm
-  100/400
-  **0,84**

RO



fondo antiscivolo

AR 4075 APRIBOTTIGLIE

Apribottiglie con funzione tappo in plastica e metallo.

i Plastica e Metallo

⊗ 9,5 x 4 cm

⊗ 100/600

€ 0,54



AR 4077 APRIBOTTIGLIE

Apribottiglie in plastica e acciaio.

i Plastica e Acciaio

⊗ 10,2 x 3,5 x 0,4 cm

⊗ 50/500

€ 0,66



AR 4070 APRIBOTTIGLIE

Apribottiglie con Fidget Spinner integrato in plastica e metallo.

i Plastica e Metallo

⊗ 8,5 x 3,5 x 1,2 cm

⊗ 50/500

€ 1,56









SET VINO CON 5 ACCESSORI

cassetta in legno

AR 4095 SET VINO

Set vino con 5 accessori in acciaio inossidabile, composti da termometro, anello salvagoccia, beccuccio versatore, tappo e cavatappi, confezione regalo (vino non incluso).





-  Cassetta in Legno
Accessori in Acciaio
-  36,4 x 11,3 x 11,3 cm
-  1/20
-  **33,90**



APRIBOTTIGLIE CAVATAPPI

AR 4080 APRIBOTTIGLIE CAVATAPPI



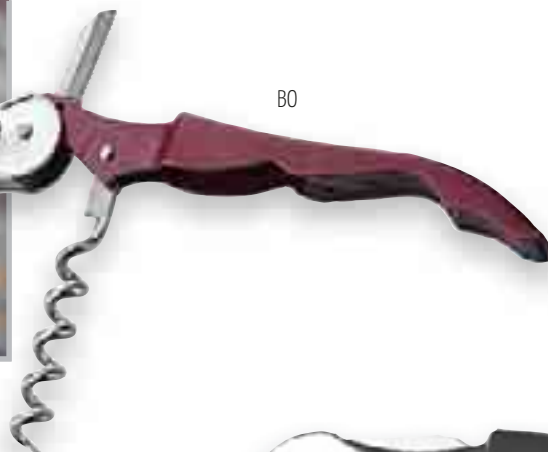

Apribottiglie in metallo.

-  Metallo
-  12,5 x 2 cm
-  50/200
-  **2,37**



AR 4060 PORTABICCHIERE





Portabicchiere da degustazione.

-  TNT
-  22 x 18 cm
-  50/200
-  **0,49**



AR 4061 PORTABOTTIGLIE

Borsa portabottiglia in tnt termosaldata, con soffietto alla base e manici fustellati.

-  TNT
-  17 x 40 x 10 cm
-  100/600
-  **1,17**







WINE&HOME

BO

AR 4062 SHOPPER PORTABOTTIGLIA

in tnt con doppio manico.

-  TNT - 80 gr/mq
-  10x33x10 cm
-  100/500
-  **0,87**







NE



BO



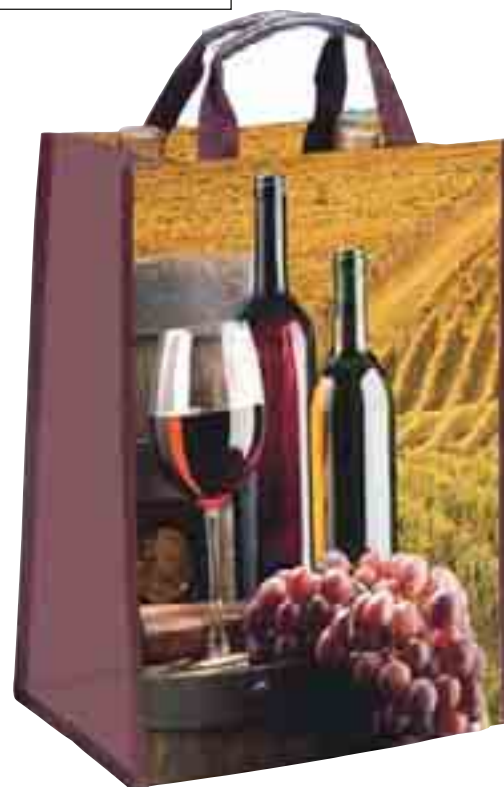

AQ 4056 BORSA WINE 37x21x10,5

Borsa porta 4 bottiglie in polipropilene.





-  Polipropilene
-  37 x 21 x 10,5 cm
-  10/100
-  **1,44**



**AY 7340
GREMBIULE UOMO**

-  Cotone 65%, poliestere 35%
260 g/mq.
-  100 x 86 cm
-  10/50
-  **11,97**

**AY 7345
GREMBIULE DONNA**

-  Cotone 65%, poliestere 35%
260 g/mq.
-  57 x 70 cm
-  10/80
-  **10,80**



BO

BO



NE



GREMBIULE
UOMO



NE



GREMBIULE
DONNA

AY 7347 GREMBIULE UOMO





Con finto Gilet con 2 tasconi.

-  Gabardine in Policotone 65%,
Poliestere 35% - 180 g/mq
-  100 x 86 cm
-  10/50
-  **16,65**



AY 7350 GREMBIULE DONNA

Con finto Gilet con 2 tasconi.

-  Gabardine in Policotone 65%,
Poliestere 35% - 180 g/mq
-  68 x 87 cm
-  10/50
-  **16,65**





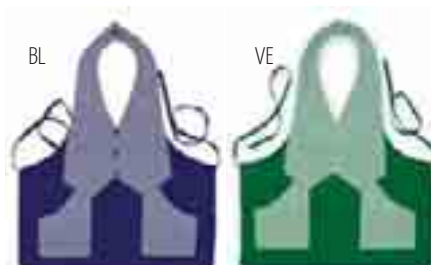

GREMBIULI IN STILE GILET UOMO e DONNA









AY 7358 GREMBIULE CONTASCONE

-  Cotone pesante 100%
210 g/mq.
-  67 x 84 cm
-  10/80
-  **8,94**



AY 7365 GREMBIULE BIANCO

Con tascone.

-  Cotone pesante 100% - 195 g/mq.
-  65 x 80 cm
-  10/100
-  **5,37**



**AY 7360
GREMBIULE
BARMAN**

Con 3 tasche

 Cotone 100% - 210 gr/mq

 56 x 36 cm





 10/50

 **5,67**

GREMBIULE IN TNT CON TASCA FRONTALE



AY 7359
GREMBIULE
Con tasca frontale cucita.

-  TNT
-  73 x 50 cm
-  10/50
-  **1,38**



BEAUTY

promosolution
2021|2022







BEAUTY

*morbido e
trasparente*

LAVILLE PARIS

AS 5035 CRYSTAL BEAUTY

Realizzato in TPU, un materiale morbidissimo e trasparente con finiture in ottone dorato, confezionato con fascia dorata LAVILLE.

-  TPU
-  21 x 10 x 7 cm
-  1/20
-  **9,90**

finiture in ottone dorato







DOPPIO SPECCHIETTO IN ECOPELLE



AS 5040 SPECCHIETTO

Specchietto in ecopelle con charms e doppio specchietto. Confezione in scatola regalo.

-  Ecopelle
-  Ø 8 cm
-  1/20
-  **8,70**

LAVILLE PARIS

confezione regalo









ICEBERG

AS 5030 POCHETTE IN PVC

Pochette in PVC lucido. Chiusura con zip.
Confezione in polybag

-  PVC
-  27 x 15 x 4,5 cm
-  1/10
-  **18,00**

POCHETTE
con chiusura zip

BEAUTY ungaro

con due scomparti

doppia zip colorata



AS 5050 BEAUTY

Beauty in poliuretano, con due scomparti a doppia
cerniera colorata.

-  Poliuretano
-  16 x 7,5 x 10 cm
-  1/10
-  **57,00**

BI



NE



FX



SI



TU

**AS 5105
SPECCHIETTO**

Specchietto da borsa in plastica.

-  Plastica / Vetro
-  Ø 6 cm
-  72/720
-  € **0,57**

*con ingrandimento***AS 5110
SPECCHIETTO**

Specchietto da borsa in plastica con ingrandimento.

-  Plastica / Vetro
-  3,2 x 6,7 cm
-  100/500
-  € **0,63**

doppio specchietto

NE



VI



SI





**AS 5102
SPECCHIETTO**

Specchietto da borsa in alluminio , con secondo specchio d'ingrandimento. Confezionato in astuccio di cartoncino.

-  Alluminio / Vetro
-  Ø 6,8 x 1,3 cm
-  50/300
-  € **1,35**

AS 5074 SPECCHIETTO "MELA"





Specchietto in PU. Confezione in astuccio.

-  Poliuretano/Vetro
-  9 x 9,5 cm
-  50/200
-  **1,95**



AS 5073 SPECCHIETTO





Specchietto da borsa estraibile con gancio portachiaavi. Dim. Ø 8 cm

-  Poliuretano e Vetro
-  Ø 8 cm
-  10/50
-  **3,75**



AS 5095 SPAZZOLA





Spazzola richiudibile con specchietto.

-  ABS / Nylon / PVC
-  10,7 x 4 x 2,8 cm
-  100/400
-  **1,44**



AS 5096 SPAZZOLA

Spazzola da viaggio richiudibile con specchio.

-  ABS / Nylon / PVC
-  Ø 6,6 x 2,9 cm
-  48/288
-  **1,44**



PENNA A SFERA



AS 5064 PENNA A SFERA

Penna in plastica a forma di rossetto. Refil blu.

-  Plastica
-  9,8 x 1,8 cm
-  100/500
-  **0,48**

PETTINE REGOLABILE



AS 5092 PETTINE

Pettine ripiegabile in plastica.

-  Plastica / Vetro
-  10 x 3,3 cm
-  100/500
-  **0,93**







ventaglio *in plastica*







AY 7758 VENTAGLIO

Ventaglio in plastica.
Area di stampa: 6x1 cm

-  ABS
-  23 x 2,2 x 2 cm
-  50/250
-  **1,56**

**AS 5115
MINILIME**

6 mini lime da unghie, nel design "dente di leone", contenute in confezione di cartoncino.

-  Carta / EVA
-  5,5 x 6,2 x 0,4 cm
-  100/500
-  **0,84**

mini lime per unghie





**AS 5116
LIME**

Lime per unghie in plastica.

-  Plastica
-  9 x 1 cm
-  50/250
-  **0,75**

**AS 5070
SET MANICURE**

Set che include forbici, lima per unghie, tagliaunghie e una cuticola implementare, dotato di astuccio con specchietto.

-  ABS / Metallo / Vetro
-  17 x 11 cm
-  25/100
-  **3,87**

in astuccio con

specchietto







POCHETTE

in nylon
satinato



AS 5125 POCHETTE





Pochette con chiusura a zip in nylon satinato.

-  Poliestere
-  17 x 12 x 5 cm
-  10/300
-  **1,89**



AS 5120 POCHETTE

Pochette con chiusura a zip in pvc satinato.

-  PVC
-  25 x 20,7 x 7,2 cm
-  50/150
-  **2,07**

POCHETTE

con zip

BI



RO



AR





OMBRELLI

promosolution
2021|2022





OMBRELLO MAXI

CON CUSTODIA E TRACOLLA



AT 5234 OMBRELLO MAXI GOLF

Ombrello con custodia e tracolla in tinta. Stecca e raggi a doppio spessore in metallo. Manico in gomma morbida.

-  Poliestere 190T
-  Ø 125 cm
-  24
-  **10,98**

OMBRELLO

IN POLIESTERE CON 8 PANNELLI



RO



AR



GI



NE



RY



AZ

AT 5214

OMBRELLO AUTOMATICO

Ombrello con otto pannelli, telaio in metallo, manico in EVA, in poliestere 170 T.

 Poliestere 170T

 Ø 106 cm

 12/120

 **8,37**







OMBRELLO IN NYLON E STRUTTURA IN ALLUMINIO

APERTURA
AUTOMATICA



AT 5210 OMBRELLO

Ombrello con apertura automatica, struttura in alluminio, manico in Eva. Rivestimento in nylon pongee.

-  Nylon Pongee
-  Ø 103 x H 82 cm
-  25
-  **9,45**

OMBRELLO CON RAGGI IN FIBRA DI VETRO

PUNTE IN
METALLO

MANICO E
STECCA IN
ALLUMINIO



BI

BL

NE



AT 5232 OMBRELLO

Ombrello Automatico con stecca in alluminio, raggi in fibra di vetro e punte in metallo, manico in alluminio-EVA, rivestimento e custodia in poliestere-pongee.

i Poliestere

o Ø 103 cm

u 36





€ 14,55

OMBRELLO AUTOMATICA 12 SPICCHI



AT 5200 OMBRELLO PIANTINO

Ombrello automatico, 12 spicchi, con finiture in metallo laccato, manico gommato effetto soft touch.

-  Poliestere
-  Ø 102 x H 85 cm
-  48
-  **7,95**

OMBRELLO AUTOMATICO A SCATTO



NE

MANICO E PUNTALE IN LEGNO



BI



GI



AR



RO



BO



FX



BL



MA

AT 5198 OMBRELLO

Ombrello a scatto automatico in poliestere.
Manico curvo e puntale in legno.



Poliestere



Ø 102 x H 89 cm



36



7.77

MINI OMBRELLO PIEGHEVOLE

CON STRUTTURA IN METALLO



VE



AR

RO

BL

BI

NE

RIVESTIMENTO E CUSTODIA
IN POLIESTERE

AT 5226 MINI OMBRELLO

Mini ombrello con apertura manuale, struttura in metallo, manico in plastica argentata, rivestimento e custodia in poliestere.



Poliestere



Ø 98 cm x H 55 cm



40



5,55

MINI OMBRELLO AUTOMATICO ANTIVENTO



**8 PANNELLI
CON APERTURA E
CHIUSURA AUTOMATICA**

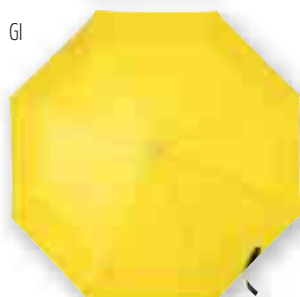

AT 5220 OMBRELLO

Ombrello pieghevole automatico "Apri & Chiudi" in pongee seta, antivento, otto pannelli, chiusura in velcro, fodera a tema colore, cordino comodo per il trasporto.

i Poliestere

o Ø 97 x 54 cm

u 36

€ 16,95

SET OMBRELLO LAVILLE

Copertura Bicolore e Manico Gommato



**CON COMODO
PORTA OMBRELLO
DA TAVOLO**

**CONFEZIONATO
IN BOX REGALO
LAVILLE**



AT 5256 OMBRELLO PIEGHEVOLE CON PORTA OMBRELLO

Un set composto da un mini ombrello 3 sezioni con copertura bicolore e manico gommato al quale è abbinato un simpatico e comodissimo porta ombrello da tavolo. Il tutto confezionato in box regalo LAVILLE.

	Poliestere	LAVILLE® PARIS
	Ø 98 cm	
	24	
	9,90	



TERMOSALDATI

promosolution
2021|2022



RO



VE



NE

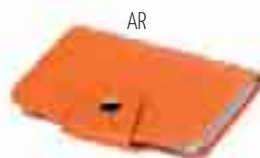

AR



BL

6 BUSTINE INTERNE

AU 5950 PORTACARD 12 POSTI

Portacard in PU con 6 bustine interne.
Chiusura con bottoncino.

-  Poliuretano
-  11 x 8 x 1,5 cm
-  10/40
-  **1,68**



AU 5952 PORTACARD RFID

Portacard esterno in similpelle, slot interna in alluminio con protezione delle card da lettori RFID, pulsante espelli carte.

-  Poliuretano/ Alluminio
-  7 x 10 x 2 cm
-  10/40
-  **8,85**

PROTEZIONE DATI DA LETTORI RFID



BL



NE



AU 5962 PORTACARD RFID

Portacard slot in alluminio con protezione delle card da lettori RFID, pulsante espelli carte, esterno rivestito in tessuto.

-  Alluminio
-  6,5x10x1,5 cm
-  20/120
-  **11,40**



NE

GR



PROTEZIONE DATI DA LETTORI RFID

BL

NE



AU 5965 PORTACARD RFID

Portacard slot in alluminio con protezione delle card da lettori RFID, pulsante espelli carte.

-  Alluminio
-  6,1 x 10 x 1 cm
-  50/500
-  **4,77**





RO





AU 5980 PORTACARD

In PU con retro adesivo . Funzione supporto smartphone.





-  PU
-  13,5 x 6,5 x 0,5 cm
-  50/250
-  **3,99**

**CON FUNZIONE
SUPPORTO
SMART PHONE**



AU 5982 PORTACARD

In PU con retro adesivo.

-  PU
-  6,6 x 9,5 x 0,3 cm
-  100/500
-  **1,47**

RETRO ADESIVO





AU 5985 PORTACARD

in silicone con retro adesivo.



-  Silicone
-  5,7 x 8,6 x 0,3 cm
-  100/500
-  **0,69**

**AU 6000
PORTACARD**

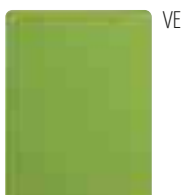

Portacard Singolo realizzato in tam.

 TAM 9 x 6 cm 100/300 0,24**AU 6010
PORTACARD**

Portacard 4 ante realizzato in tam, contiene 10 card.

 TAM 10 x 7,5 cm 100/300 0,87**AU 6005
PORTACARD**

Portacard 2 ante realizzato in tam.

 TAM 9 x 6 cm 100/300 0,42

VE



SI



BL



BI







RO



AU 6038 PORTACARD

Portacard singolo realizzato in PVC elite.

-  PVC
-  9,2 x 6 cm
-  100/500
-  € **0,15**



SI



BL



BI

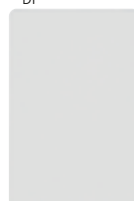





RO



AU 6041 PORTACARD

Portacard 2 ante realizzato in pvc elite.

-  PVC
-  9,2 x 6 cm (chiuso)
-  100/500
-  € **0,26**



SI



BL



BI

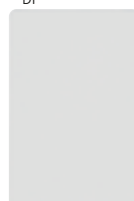





RO



AU 6039 PORTACARD

Portacard 3 tasche realizzato in pvc elite.

-  PVC
-  9,2 x 6 cm (chiuso)
-  100/500
-  € **0,39**



SI



BL



BI

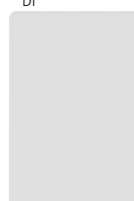





RO



AU 6033 PORTACARD

Portacard 4 bustine, può contenere 10 card, realizzato in pvc elite.

-  PVC
-  9,4 x 6,7 cm
-  100/500
-  € **0,67**



AU 5970 PORTACARD RFID

Portacard progettato per proteggere la tua carta di credito dalle scansioni di dati bancari dei lettori RFID. Composizione: PE con foglio alluminio interno.

 PE + Alluminio

 9 x 6,1 cm

 100/200

 0,26





**PROTEZIONE DATI
LETTORI RFID**

AU 6020 PORTAOGGETTI PORTAMASCHERINA

Bustina portaoggetti/portamascherina in pvc.

 PVC

 12 x 12 cm (chiuso)

 100/500



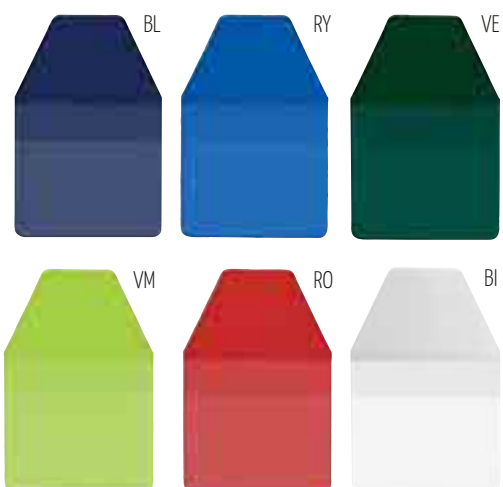

 0,36





AU 6030 PORTALOTTO

Portalotto 2 ante in PVC.

-  PVC
-  22,5 x 12 cm (chiuso)
-  100/300
-  **0,48**



BI

BL

RO



AU 6027 PORTALOTTO

Portalotto in pvc con pattina di chiusura.

-  PVC
-  23x12,5 (chiuso)
-  100/300
-  **0,66**



BL





RO

BI



AU 6057 PORTA RICETTE PORTATESSERE

Per farmacia in tam.

-  TAM
-  22 x 16,5 cm
-  100/300
-  2,67



AU 6052 PORTARICETTE PORTATESSERE PORTASCONTRINI

2 ante realizzato in alfa.

-  PVC
-  17 x 12 cm
-  100/300
-  0,99



VE





SI





AU 6035 PORTA NOME





Per bagaglio in DEVLON.

-  DEVLON
-  10 x 6 cm
-  100/500
-  **0,48**



AU 6027 PORTABIGLIETTO AEREO

In pvc con pattina di chiusura.

-  PVC
-  23 x 12,5 (chiuso)
-  100/300
-  **0,66**



RO



BI

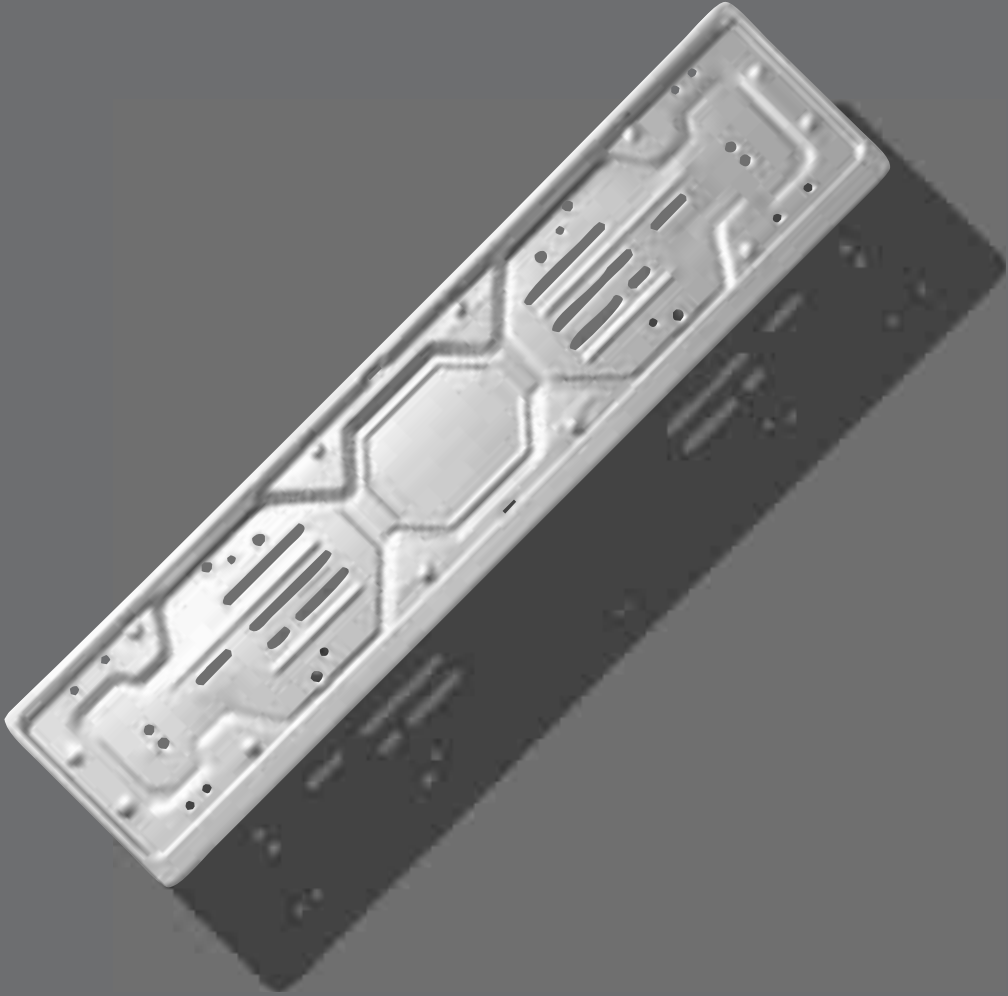





AUTO & MOTO

promosolution
2021|2022



AV 6245
PORTADOCUMENTI
 Auto chiusura con bottone.





-  Sughero e PU
-  19 x 13 cm
-  100
-  **2,70**



in Sughero e PU



AV 6241
PORTADOCUMENTI
 Portadocumenti in tam bicolore con bottone.

-  TAM
-  19 x 13 cm
-  50/200
-  **1,20**







in TAM bicolore



AV 6240 PORTADOCUMENTI

Portadocumenti con fascetta in tam bicolore.





-  TAM
-  19 x 13 cm
-  50/200
-  **0,90**



PORTADOCUMENTI IN TAM BICOLORE

AV 6243 PORTADOCUMENTI MOTO

Portadocumenti con pattina realizzata in tam.

-  TAM
-  16,5 x 13 cm
-  50/300
-  **0,87**









**PORTA
DOCUMENTI
CON CUCITURE
COLORATE**



**AV 6205
PORTADOCUMENTI**





Portadocumenti in Tam, con cuciture colorate.

-  TAM
-  18,5 x 13 cm
-  100
-  **3,27**



**AV 6210
PORTADOCUMENTI**





Portadocumenti in Tam, con cuciture colorate.

-  TAM
-  20 x 14 cm
-  100
-  **2,85**



**AV 6239
PORTADOCUMENTI**

Portadocumenti con fascetta in tam bicolore con bottone.

-  TAM
-  19,5 x 14 cm
-  100
-  **2,85**



BL







GR



AV 6242 PORTADOCUMENTI

Portadocumenti Realizzato in TAM con tasca trasparente.

-  TAM
-  18 x 13 cm
-  50/500
-  **0,57**



AR

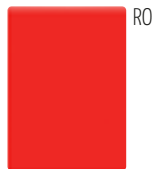

RO



FX



VM



AZ



BL

AU 6042 PORTADOCUMENTI MOTO





Portadocumenti realizzato in PVC con tasca trasparente.

-  PVC
-  18 x 13 cm
-  100/500
-  **0,33**



AV 6250 DISCO ORARIO





Disco orario in PVC.

-  PVC
-  15 x 11,7 cm
-  50/500
-  **0,48**



AU 6055 PORTAPOLIZZA

Porta polizza in PVC con tasca trasparente.

-  PVC
-  25,5 x 18,5 cm
-  100/500
-  **0,42**







BL

BI







**AV 6280
PORTATARGA
POSTERIORE AUTO**
Portatarga in metallo verniciato grigio.

 Metallo
 53,5 x 13,5 cm
 100
 **4,17**



**AV 6285
PORTATARGA
ANTERIORE AUTO**
Portatarga in metallo verniciato grigio.

 Metallo
 37,5 x 13,5 cm
 100
 **3,57**



**AV 6260
PORTATARGA
POSTERIORE AUTO**
Portatarga in metallo alluminio grigio.

 Alluminio
 53,5 x 13,5 cm
 100
 **4,95**







**AV 6265
PORTATARGA
ANTERIORE AUTO**
Portatarga in metallo alluminio grigio.

 Alluminio
 37,5 x 13,5 cm
 100
 **4,35**



AV 6270 PORTATARGA POSTERIORE AUTO





Portatarga in metallo verniciato nero.

-  Metallo
-  53,5 x 13,5 cm
-  100
-  **4,17**



AV 6275 PORTATARGA ANTERIORE AUTO





Portatarga in metallo verniciato nero.

-  Metallo
-  37,5 x 13,5 cm
-  100
-  **3,57**



AV 6292 PORTATARGA POSTERIORE AUTO

In polipropilene fornito con listello in alluminio colore silver

-  Polipropilene
-  52,5 x 13,5 cm
-  100
-  **3,87**



**LISTELLI IN
ALLUMINIO
FORNITI SU
RICHIESTA IN
ALTERNATIVA
AL LISTELLO
SILVER.**

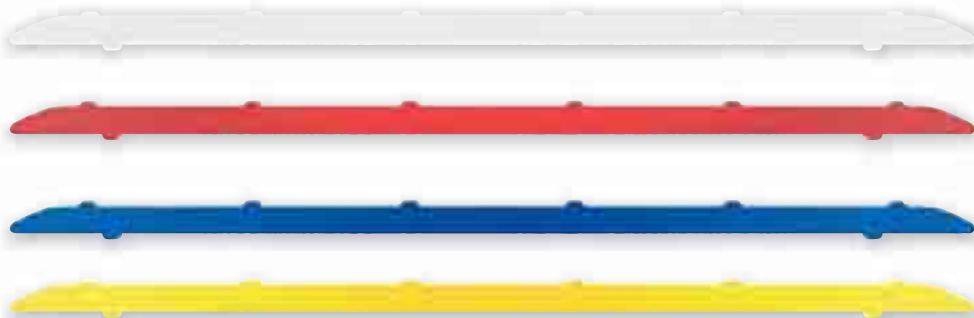

BI

RO





BL

GI



AV 6290 PORTATARGA POSTERIORE AUTO





Portatarga in polipropilene nero.

-  Polipropilene
-  52,5 x 13 cm
-  100
-  € **2,07**



AV 6295 PORTATARGA POSTERIORE AUTO





Portatarge in polipropilene argentato.

-  Polipropilene
-  52,5 x 13 cm
-  100
-  € **2,37**



AV 6315 PORTATARGA PER MOTO





Portatarga in metallo Grigio.

-  Metallo
-  19,5 x 23 cm
-  100
-  € **3,27**



AV 6320 PORTATARGA PER MOTO





Portatarga in Metallo Nero.

-  Metallo
-  19,5 x 23 cm
-  100
-  € **3,27**



AV 6339 PORTATARGA PER MOTO

Portatarga in ABS.

-  ABS
-  18,5 x 20 cm
-  100
-  € **1,47**









UTILITY

promosolution
2021|2022



AW 6515 DOPPIO METRO IN ABS

-  ABS
-  L. 2 mt
-  20/200
-  **4,17**





AW 6520 MATITA FALEGNAME

-  Legno
-  17x1 cm
-  100/1000
-  **0,25**



AW 6525 DOPPIO METRO IN LEGNO

-  Legno
-  2 mt
-  12/120
-  **4,35**

**AW 6553
FLESSOMETRO**

Flessometro a nastro 5 m in ABS con freno e clip in metallo.

-  Plastica e Metallo
-  7,5 x 7 x 4 cm
-  10/100
-  4,65





5 mt



Pulsante Stop &
CLIP DA CINTURA

**AW 6555
FLESSOMETRO**

Flessometro a nastro 3 m in ABS con freno e clip in metallo.

-  Plastica e Metallo
-  6 x 6 x 3,5 cm
-  10/100
-  3,57

3 mt

**AW 6565
ROTELLA METRICA**

Rotella metrica 20 mt. in plastica gialla e nera

-  Plastica
-  L. 20 mt
-  10/30
-  11,25

20 mt









RO



BL

**AW 6529
CUTTER**

Cutter rettangolare in plastica.

-  Plastica
-  10,2 x 3 x 1 cm
-  60/180
-  **0,75**



AR







GI



AZ



**AW 6526
CUTTER**

Cutter in plastica trasparente.

-  Plastica
-  12,6 x 2,5 x 1 cm
-  60/180
-  **0,84**

**AW 6570
COLTELLINO
3 FUNZIONI**

Coltellino tre funzioni in plastica e acciaio inox.

-  ABS/ Acciaio
-  6,2 x 2,2 x 1 cm
-  20/200
-  **1,98**

**AW 6524
CUTTER**





Cutter in acciaio inox

-  Acciaio
-  12,8 x 1,1 x 0,9 cm
-  100/500
-  **0,69**



AW 6530 BORSA PER BICICLETTA

in 600D con fasce regolabili a strappo, tasca esterna con chiusura a zip.

-  Poliestere 600D
-  23 x 20 x 6 cm
-  10/100
-  4,05



Tasca per bicicletta

AW 6532 SET BICICLETTA

Set accessori per la riparazione delle forature dei pneumatici, contiene leva per pneumatici, grattugia, toppe autoadesive e gomma per valvole, custodia in plastica.

-  Plastica
-  12,5 x 3,5 x 2,8 cm
-  20/200
-  3,99



kit riparazione foratura

AW 6535 SET CACCIAVITI

in ABS e metallo, 24 punte di precisione, impugnatura del cacciavite magnetica per tenere le punte in posizione e rendere facile la sostituzione, apertura laterale PUSH.

-  ABS e Metallo
-  16,7 x 6,8 x 1,9 cm
-  25/100
-  9,99



set cacciavite



AW 6584 PORTAPILLOLE

Portapillole in plastica trasparente a 3 scomparti.

-  Plastica
-  6 x 3,5 cm
-  100/500
-  € **0,33**



VE



BL



RO



BI





AW 6583 PORTAPILLOLE

Portapillole in plastica 4 scomparti.

-  Plastica
-  7,9 x 6,3 x 1,6 cm
-  50/250
-  € **0,99**

AW 6587 PORTAPILLOLE

Portapillole in plastica bianca a 3 scomparti.

-  Plastica
-  6,5 x 3,5 x 1,5 cm
-  100/500
-  € **0,54**



AW 6586 TAGLIA PILLOLE

Taglia pillole "Easy Cut" in plastica bianca, dotato, all'interno, di un piccolo coltello che divide la pillola richiudendo la scatola.

-  Plastica
-  Ø 7 cm
-  50/300
-  € **0,69**



**AW 6596
LANYARD**

con flacone spray in plastica, contenente alcool al 70%, torcia con luce LED.

-  Plastica
-  Ø 1,2x10,8 cm
-  50/200
-  **2,25**



BI

BL

RO

**AW 6589
DIFFUSORE SPRAY**

Disinfettante spray tascabile.

-  Plastica
-  1,6 x 14 cm
-  50/250
-  **1,11**

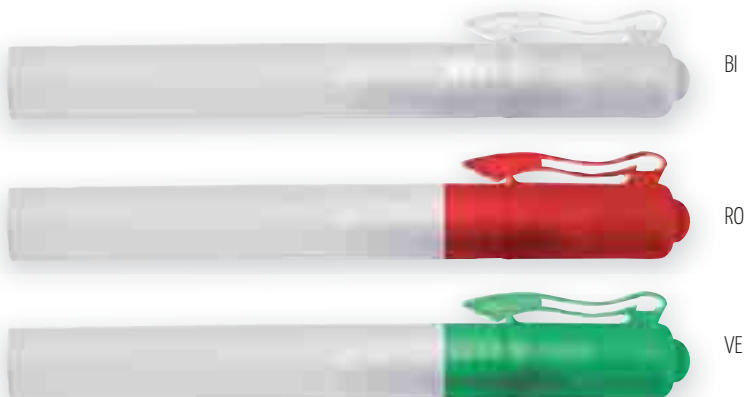





BI

RO

VE

**AW 6591
SPAZZOLINO**

Spazzolino da viaggio.

-  Plastica
-  10,3 x 2,4 x 1,5 cm
-  125/600
-  **0,75**

**AW 6595
LEVA FUSTELLE**





Levafustelle in plastica e acciaio.
Confezione in polybag.

-  Plastica
-  13 cm
-  100/500
-  **2,37**







**AW 6599
PORTABITI**

in TNT (70 g/m²) con cerniera e impugnatura per un facile trasporto.

-  TNT
-  60 x 100 cm
-  50/250
-  **4,65**

**AW 6602
BORSA PORTASCARPE**

Borsa in tessuto non tessuto (80 g/m²) chiusura con coulisse.

-  TNT
-  36 x 42 cm
-  100/500
-  **1,32**





**AW 6603
SACCHETTO ERMETICO**

per cosmetici in PVC. Include 2 flaconcini (65 ml e 60 ml), 1 vaporizzatore (80 ml) e 1 imbuto. Adatto per il trasporto in cabina.

-  PVC
-  19 x 15,5 x 4 cm
-  10/100
-  **3,99**

**AW 6600
CALZASCARPE**

in PS con foro per essere appeso.

-  PS
-  15,3 x 3,8 cm
-  100
-  **0,54**

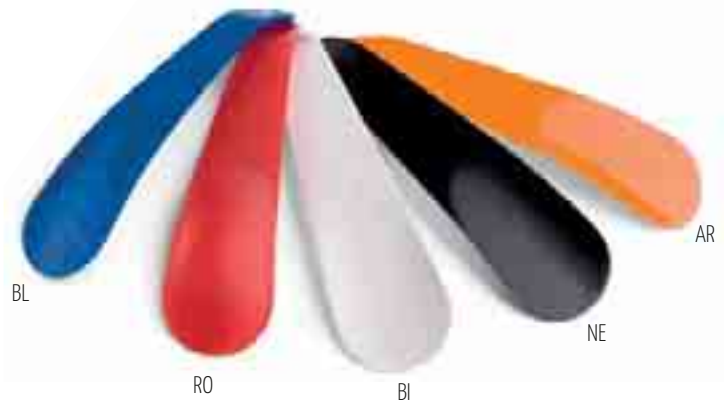



ZAINI & SPORTBAG

promosolution
2021|2022

ZAINO IN POLIESTERE PER TABLET E COMPUTER







Spallacci regolabili

**SCOMPARTI
IMBOTTITI
CHIUSURE
DOPPIA ZIP**



AF 1655 ZAINO PORTACOMPUTER

Zaino in poliestere con due scomparti con chiusura a doppia zip, scomparto con interno imbottito per tablet e computer portatile 15", scomparto secondario con varie tasche interne, tre tasche esterne frontali con cerniera più due tasche laterali, due spallacci imbottiti e regolabili, in elegante scatola regalo.

-  Poliestere
-  35 x 45 x 18 cm
-  1/10
-  **134,70**

ZAINO IN POLIESTERE PER TABLET E COMPUTER







chiusura doppia zip

**SCOMPARTI
IMBOTTITI**

AF 1664 ZAINO MAGNUM

Zaino in nylon con chiusura a doppia zip, tasca interna imbottita portacomputer, tasca portatablet, varie tasche interne, spallacci rebolabili imbottiti. Tasca laterale con chiusura a zip e tasca antifurto segrata sul retro con cerniera. Porta usb esterna e chiusura TSA integrata. Confezionato in elegante scatola regalo.

-  Nylon
-  47 x 33 x 17 cm
-  1/10
-  **119,70**





ZAINO ANTI FURTO





TASCA PER
COMPUTER 15"

PORTA USB ESTERNA







AF 1659 ZAINO ANTIFURTO

Zaino bicolore semirigido, parte centrale in nylon e parte superiore e inferiore in PVC, ampio scomparto interno, tasca porta computer da 15 pollici, varie tasche interne, porta USB esterna con cavo all'interno, tasca segreta con cerniera sul retro, bretelle imbottite regolabili.

-  Nylon + PVC
-  45 x 35 x 11 cm
-  1/10
-  **62,40**

AF 1663 ZAINO MARTIN

Zaino in poliestere con chiusura a doppia zip, tasca interna imbottita portacomputer, varie tasche interne, spallacci regolabili. Doppia tasca esterna con chiusura a zip. Porta usb esterna.

-  Poliestere
-  42 x 34 x 10 cm
-  1/25
-  **25,50**

ZAINO IN POLIESTERE



GR



NE



**DOPPIA ZIP
DI CHIUSURA**



**DOPPIA
TASCA
ESTERNA
CON
CHIUSURA
ZIP**



**TASCA
INTERNA PER
COMPUTER
IMBOTTITA**



ZAINO

PORTA COMPUTER 15 pollici

scomparto principale imbottito

AF 1665 ZAINO PORTACOMPUTER

Zaino portacomputer 15 pollici, scomparto principale con vano imbottito per un portatile, tasche interne, vano sulla parte anteriore con chiusura lampo, manico, spallacci regolabili.

 Poliestere 600D e PVC

 44 x 28,5 x 12 cm

 1/10

 74,70



ZAINO IN NYLON PORTACOMPUTER

Due Tasche

ZAINI&SPORTBAG



AF 1669 ZAINO PORTACOMPUTER

Zaino in nylon con due scomparti, scomparto principale con interno imbottito per computer portatile, scomparto secondario con varie tasche interne, due tasche esterne frontali con cerniera e due tasche a rete sui lati, due spallacci imbottiti, manico con impugnatura ergonomica .



Nylon



45 x 30 x 15 cm



1/10



38,85



BL



ZAINO IN POLIESTERE







NE

DOTATO DI
MOSCHETTONE
USCITA PER
AURICOLARI
2 SCOMPARTI
LATERALI
A RETE

AZ 7025 ZAINO

Zaino con scomparto frontale a cerniera dotato di gancio a moschettone, scomparto principale a cerniera con tasca e all'interno tasca piccola a cerniera come pure uscita per gli auricolari, 2 scomparti a reti sui lati e lacci comprimenti, manico rinforzato, spalline e schienale con comoda imbottitura.

-  Poliestere 1680D
-  48 x 32 x 18 cm
-  1/15
-  **29,25**

ZAINO IN POLIESTERE PORTACOMPUTER



NE

SPALLACCI
REGOLABILI



RO

SCHIENALE
IMBOTTITO



RY



AZ 7022 ZAINO

Zaino in poliestere 600D con ampia tasca interna imbottita portacomputer. Schienale imbottito, spallacci regolabili salvaspalle. Tasca esterna con zip. Tasca laterale in rete mesh.



Poliestere 600D



31 x 41 x 11 cm



1/25



11,40

ZAINO IN POLIESTERE CON SPALLINE REGOLABILI



RO

spalline imbottite

AZ 7032 ZAINO

Con tasca anteriore a cerniera, scomparto principale, spalline imbottite regolabili.



Poliestere 600D



33 x 41 x 19 cm



10/50



8,07



GI



VM



BI



AR



BL



NE

ZAINO IN POLIESTERE

TASCA ANTERIORE CON CERNIERA







VM

spalline imbottite

AZ 7033 ZAINO

Con tasca anteriore a cerniera, scomparto principale, spalline imbottite regolabili.

-  Poliestere 600D
-  30 x 39,5 x 10 cm
-  10/50
-  6,45







ZAINO IN POLIESTERE CON SPALLINE IMBOTTITE



USCITA PER AURICOLARI
TASCA ESTERNA CON CERNIERA
SCOMPARTI LATERALI IN RETE

AZ 7028 ZAINO

Con scomparto frontale a cerniera con uscita per auricolari, una tasca esterna a cerniera, maniglia, 2 scomparti esterni a rete sui lati, spalline imbottite.

-  Poliestere 600D
-  40 x 28,5 x 17 cm
-  10/50
-  6,27



ZAINO LEGGERO

TASCA FRONTALE CON CERNIERA

NE





AZ 7023 ZAINO

Zaino leggero e compatto con spallacci regolabili,
tasca frontale con cerniera verticale.

 Poliestere 600D - 145 gr/mq

 23 x 40 x 12 cm

 10/50

 **4,47**

spallacci regolabili

BL



BI



VM



GI



AR



RO



ZAINETTO CON CORDONCINO DI CHIUSURA

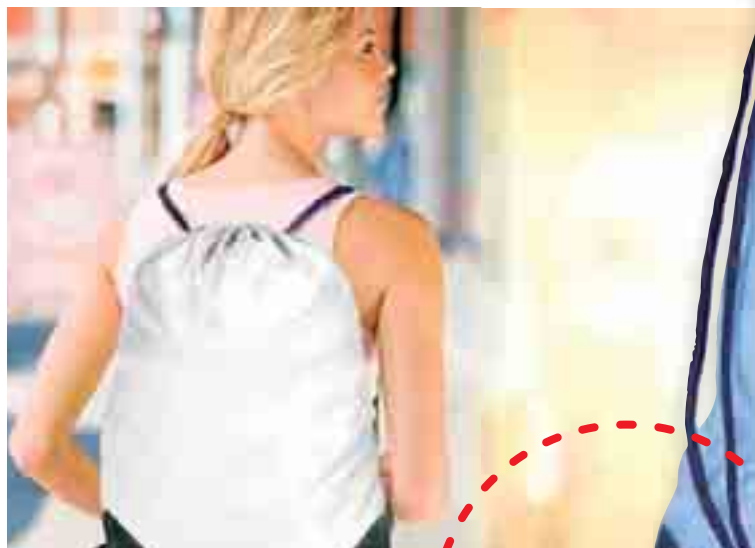





AZ

ANGOLI RINFORZATI



AZ 7019 ZAINETTO POLIESTERE

Con doppio cordoncino di chiusura, angoli rinforzati, poliestere 210 D.

-  Poliestere 210D
-  42 x 33 cm
-  10/100
-  **1,35**

ZAINETTO IN POLIESTERE

TASCA ESTERNA CON ZIP



RO

RY



BI



GI



NE



AZ 7018 ZAINETTO POLIESTERE

Con doppio cordoncino di chiusura, tasca esterna con zip e uscita per auricolari, angoli rinforzati.

 Poliestere 210D

 45 x 35 cm

 10/50

 2,07

ZAINETTO TNT

CON DOPPIO
CORDONCINO
DI CHIUSURA



AZ 7031 ZAINETTO TNT

Con doppio cordoncino di chiusura in tessuto non tessuto.

 TNT - 80gr/mq

 42 x 36 cm





 20/100

 1,08



AZ 7015 ZAINO CAMOUFLAGE

In poliestere 210D con angoli rinforzati.





-  Poliestere 210D
-  44 x 34 cm
-  10/50
-  **1,95**

ZAINETTI CAMOUFLAGE IN POLIESTERE



AZ 7016 ZAINO CAMOUFLAGE

Richiudibile in poliestere 190T.

-  Poliestere 190D
-  43 x 29 x11 cm
-  10/50
-  **4,65**



RICHIUDIBILE





AZ



RO



AR



GI



VE



GR

TRACCOLLA REGOLABILE

BORSONE SPORTIVO BICOLORE DOPPIO MANICO

AZ 7113 BORSONE SPORTIVO

Bicolore, ampio vano centrale, tasche laterali e tasca anteriore, doppio manico, tracolla regolabile, confezione in polybag.

i Poliestere 600D

o 55 x 33 x 28 cm

o 1/20

€ 13,35

BORSONE SPORTIVO

SCOMPARTO E
TASCHE CON
CERNIERE



AZ

FONDO E MANICI RINFORZATI



FX



AR



RO



GR



BL



VE

AZ 7115 BORSA SPORTIVA

Borsa in poliestere 600D, con tracolla regolabile, scomparto principale più tasca laterale con cerniere, manici e fondo rinforzati.

i Poliestere 600D

o 48 x 28 x 22 cm

u 1/20

€ 11,70

RO



BORSONE SPORTIVO IN POLIESTERE



BL



NE



ZIP DOPPIO
CURSORE
VANO PORTA
SCARPE

AZ 7116 BORSONE SPORTIVO

Con ampio scomparto centrale chiusura zip doppio cursore, tasca esterna con zip, vano laterale porta scarpe, doppio manico e tracolla regolabile.

i Poliestere 600D

o 56 x 30 x 28 cm

o 1/30

€ 20,25

BORSA SPORTIVA

CON GRANDE
SCOMPARTO
SEPARATO
PER SCARPE



NE



FONDO RESISTENTE ALL'ACQUA





BL

AZ 7125 BORSA SPORTIVA

Borsa sportiva con grande scomparto separato per scarpe, scomparto principale e 2 tasche laterali con cerniera, tasca sul retro, fondo resistente all'acqua, tracolla regolabile e asportabile fornita di parte imbottita.

 Poliestere 600D

 60 x 36 x 26 cm





 1/15

 9.73



AZ 7120 BORSA SPORTIVA

Borsa sportiva 2 IN 1: ampio scomparto principale con cerniera, tasca frontale con cerniera, 1 tracolla aggiuntiva, 2 tasche laterali con cerniera, maniglie rinforzate per il trasporto, utilizzabile anche come zaino.

-  Poliestere 300D/600D
-  55 x 30 x 28 cm
-  1/20
-  **8,75**

BL



BORSA ZAINO 2 IN 1

TASCA
FRONTALE
TRACOLLA
AGGIUNTIVA
CHIUSURE ZIP

GR



2 TASCHE LATERALI





TEMPO LIBERO

promosolution
2021|2022

BL

**AY 7732
BORRACCIA**

Borraccia botton push, beccuccio pieghevole, in acciaio inossidabile, tappo in plastica a tema colore, capacità **600 ml**.





-  Acciaio inossidabile
-  Ø 7,5 x 23 cm
-  35
-  **9,75**

BORRACCIA IN ACCIAIO BOTTON PUSH

BORRACCIA IN ACCIAIO DOPPIA PARETE

**AY 7736
BORRACCIA**



Borraccia in acciaio inossidabile a doppia parete, tappo a vite, capacità **500 ml**.

-  Acciaio inossidabile
-  Ø 6,8 x 25,7 cm
-  40
-  **11,70**



**AY 7730
BORRACCIA**

Borraccia waterproof con moschettone, in alluminio, capacità 400 ml.

-  Alluminio
-  Ø 6,6 x 17,5 cm
-  48
-  3,45

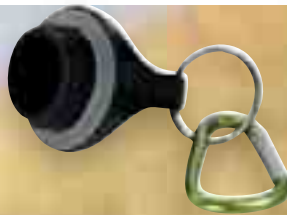
**BORRACCIA
IN ALLUMINIO****CON MOSCHETTONE****BORRACCIA
IN ALLUMINIO
WATERPROOF**

AR

**AY 7731
BORRACCIA**





Borraccia waterproof con moschettone, in alluminio, capacità 750 ml.

-  Alluminio
-  Ø 7,3 x 25 cm
-  60
-  4,95



AY 7741 BORRACCIA

Borraccia in Tritan con chiusura ermetica, tappo in acciaio inossidabile, cinturino da polso, **capacità 500 ml.**

-  TRITAN
-  Ø 6,6 x 20 cm
-  XXX
-  **4,47**



BORRACCIA IN TRITAN CHIUSURA ERMETICA TAPPO IN ACCIAIO

BORRACCIA IN VETRO CON GUAINA PROTETTIVA



AY 7743 BORRACCIA

Borraccia in vetro con tappo a vite e passamano, ricoperta da guaina protettiva colorata estraibile, **capacità 450 ml.**

-  Vetro
-  Ø 6,5 x 18,5 cm
-  40
-  **3,57**

**AR 4120
TAZZA**

Tazza bianca con trattamento per sublimazione, astuccio incluso. **Capacità 325 ml.**

-  Ceramica
-  Ø 8,1 x H 9,5 cm
-  36/144
-  **2,67**



trattamento per sublimazione

**AR 4121
TAZZA**

Tazza bianca con bordo e manico colorati. Astuccio incluso. **Capacità 300 ml.**

-  Ceramica
-  Ø 8,2 x H 9,5 cm
-  36/144
-  **3,15**

**AR 4122
TAZZA FLUO**

in ceramica fluorescente personalizzabile in sublimazione o con incisione laser. **Capacità 325 ml.**

-  Ceramica
-  Ø 8,1 x H 9,5 cm
-  36/144
-  **3,57**



IN CERAMICA
FLUORESCENTE
PER
SUBLIMAZIONE
O LASER



BICCHIERE 400ml



in fibra di riso

**AR 4115
BICCHIERE**

Bicchiere in fibra di riso e PP.
Capacità 400 ml.





-  Fibra di riso e PP
-  Ø88 x 102 mm
-  50/200
-  **1,95**

CONTENITORE CIBO
CON POSATE

biodegradabile

**AR 4132
LUNCH BOX**





Contenitore cibo con coltello e forchetta in paglia di grano biodegradabile. Capacità 500 ml.

-  Paglia di grano
-  16,5 x 11,3 x 4,4 cm
-  10/50
-  **5,55**



AR 4130 CONTENITORE CIBO

Contenitore Cibo ermetico in PP con 3 scomparti (250 ml, 270 ml e 470 ml). Forchetta e coltello incluse. Adatto per microonde (rimuovere il coperchio).

-  Polipropilene
-  23,5 x 19,5 x 6 cm
-  5/60
-  3,99





adatto a microonde



CONTENITORE ERMETICO 3 SCOMPARTI

AY 7745 BICCHIERE

Bicchiere in plastica telescopico, custodia con moschettone. Capacità 220 ml.

-  Ceramica
-  Ø 6,8 x 9 cm
-  36/144
-  1,98

CUSTODIA CON MOSCHETTONE







RO



BORSA TERMICA CON TRACOLLA REGOLABILE

AZ 7077 BORSA TERMICA

Borsa con scomparto principale isolante a cerniera, tasca laterale e tracolla regolabile.

-  Poliestere 420D
-  23 x 16 x 26 cm
-  1/25
-  **8,34**

AZ



BL



RO



VE



SCOMPARTO PRINCIPALE CON ZIP







**AY 7757
COPERTA**

Coperta in pile, con maniglia in nylon.

-  Pile - 180 gr/mq
-  160 x 125 cm
-  1/20
-  **10,95**

**COPERTA
IN PILE****AY 7753
BORSA CAPRI**

Multiuso richiudibile a strappo, manici in elegante corda di cotone con fori in metallo, ideale per spiaggia, spesa e il tempo libero.

-  Poliestere 300D
-  45 x 35 x 18 cm
-  1/30
-  **9,90**

FX





IDEALE PER IL TEMPO LIBERO

PALLONE DA MARE BICOLORE



AY 7765 PALLONE

Pallone da mare bicolore con spicchi alternati colorati.

-  PVC
-  Ø 26 cm
-  50/300
-  **1,44**

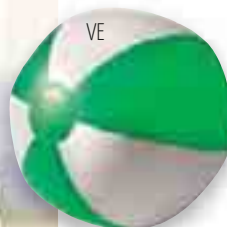





CUSTODIA
PROTETTIVA
IN PVC CHE
CONSENTE
L'ATTIVAZIONE
DIRETTA DELLO
SCHERMO







AY 7766 PORTACELLULARE

Custodia protettiva impermeabile in PVC, resistente all'acqua per dispositivi mobile, cordino con chiusura di sicurezza lungo circa 46 cm. Grazie allo speciale materiale della custodia è possibile azionare direttamente lo schermo del proprio mobile.

-  PVC
-  26 x 11,1 x 0,1 cm
-  10/500
-  **1,56**



AY 7751
OCCHIALI DA SOLE
 Modello classico, con protezione UV 400

-  PVC/ Policarbonato
-  14 x 4,5 cm
-  50/250
-  **1,77**



OCCHIALI DA SOLE CON
 PROTEZIONE **UV 400**



ventaglio
in plastica

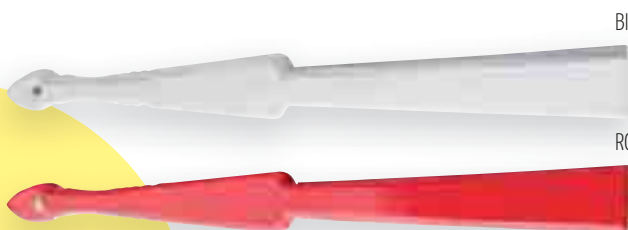

AY 7758
VENTAGLIO

Ventaglio in plastica.
 Area di stampa: 6x1 cm

-  Plastica
-  23 x 2,2 x 2 cm
-  50/250
-  **1,56**

AM 2565 POSACENERE TASCABILE

In PVC, Richiudibile con bottone.

-  PVC
-  8 x 8 cm
-  50/500
-  **0,87**



NE

POSACENERE TASCABILE CHIUSURA CON BOTTONE



AN 2896 BRACCIALETTO

Braccialetto in Tyvek con chiusura adesiva.

-  Tyvek
-  24,5 x 1,9 cm
Area di stampa: 6 x 1 cm
-  100/500
-  **0,11**

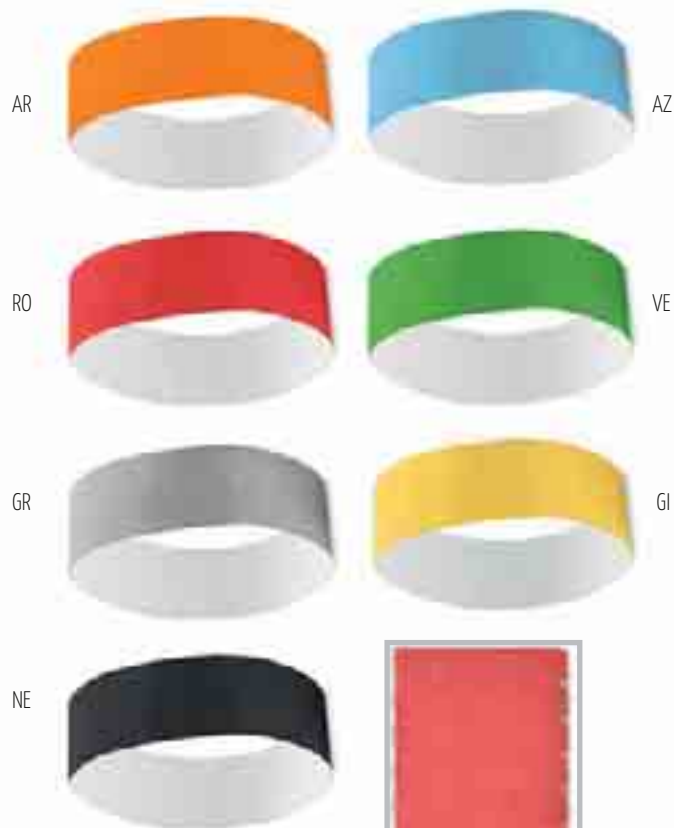

Fornito a strisce da 10 pz.





T-SHIRT

promosolution
2021|2022



SUNSET T-SHIRT

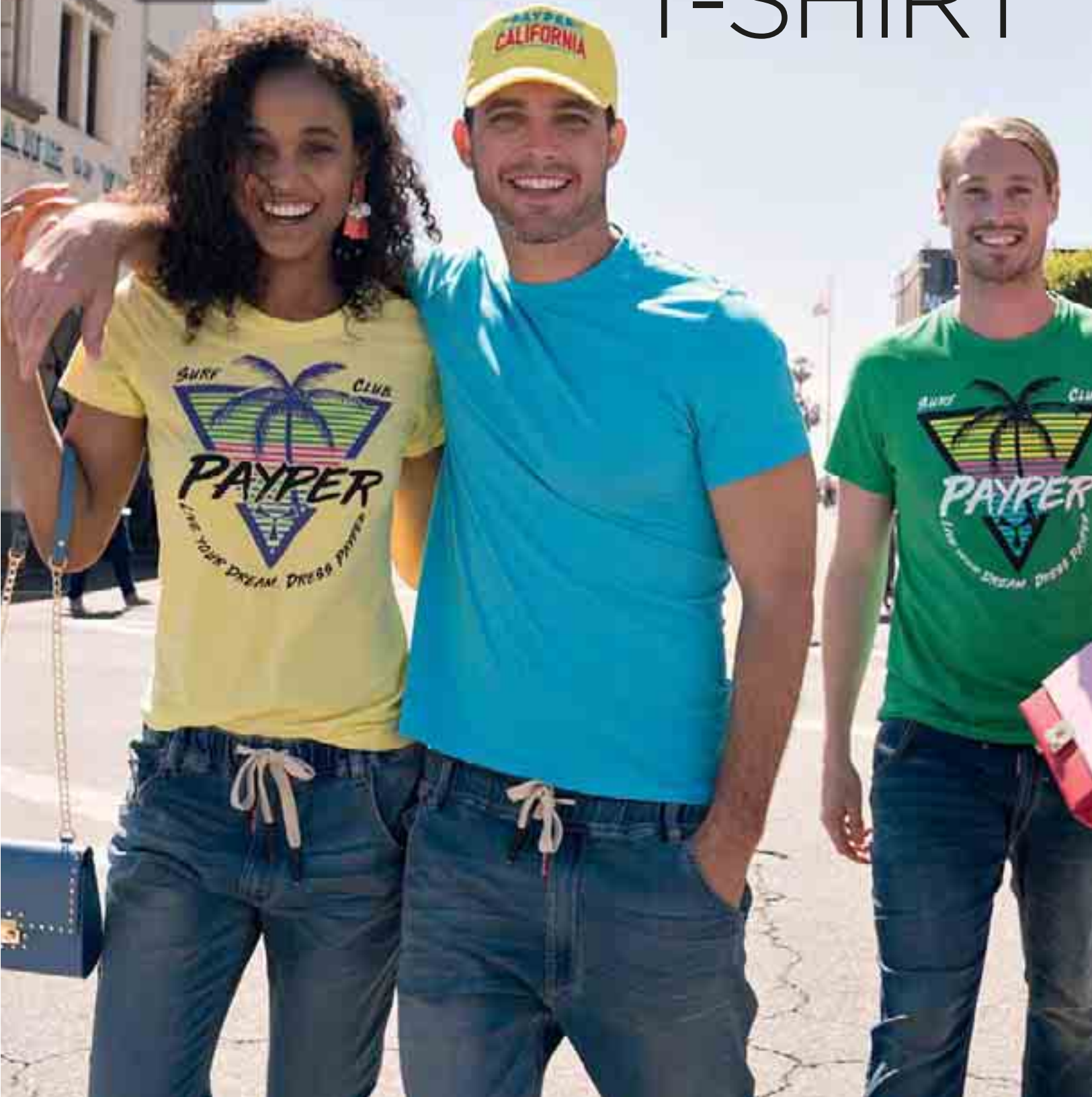



TUTTI I COLORI





DELL'ESTATE



BI

AY 7443 SUNSET





T-Shirt girocollo, manica corta, colletto in costina misto spandex da 1,5 cm con cucitura ribattuta, nastro di rinforzo da spalla a spalla, struttura tubolare. Priva di busta per confezionamento.

-  Cotone - 150 g/mq
-  XS - S - M - L - XL - XXL - 3XL
(colori Blu, Royal, Melange, Nero, Smoke, Arancio, Rosso disponibili anche 4XL - 5XL)
-  5/100
-  **6,43**



AY 7443-BI SUNSET WHITE

T-Shirt girocollo, manica corta, colletto in costina misto spandex da 1,5 cm con cucitura ribattuta, nastro di rinforzo da spalla a spalla, struttura tubolare. Priva di busta per confezionamento.

-  Cotone - 150 g/mq
-  XS - S - M - L - XL - XXL
3XL - 4XL - 5XL
-  5/100
-  **5,66**



SUNSET LADY









CON TAGLIO

SFIANCATO

**AY 7446
SUNSET LADY**





T-Shirt girocollo, manica corta, colletto in costina misto spandex da 1,5 cm con cucitura ribattuta, nastro di rinforzo da spalla a spalla, taglio sfiancato. Priva di busta per confezionamento.

-  Cotone - 150 g/mq
-  XS - S - M - L - XL
(Nero, Blu, Smoke, Royal disponibili anche XXL)
-  5/100
-  **6,43**



**AY 7446-BI
SUNSET LADY WHITE**

T-Shirt girocollo, manica corta, colletto in costina misto spandex da 1,5 cm con cucitura ribattuta, nastro di rinforzo da spalla a spalla, struttura tubolare. Priva di busta per confezionamento.

-  Cotone - 150 g/mq
-  XS - S - M - L - XL - XXL
-  5/100
-  **5,66**







COLLETTO IN COSTINA

STRUTTURA TUBOLARE



AY 7450 PRINT





T-Shirt girocollo, manica corta, colletto in costina misto spandex da 1,5 cm con cucitura ribattuta, nastro di rinforzo da spalla a spalla, struttura tubolare. Busta per confezionamento non inclusa.

-  Cotone Jersey- 150 g/mq
-  XS - S - M - L - XL - XXL - 3XL
(Blu, Royal, Nero, Steel Gray disponibili anche 4XL - 5XL)
-  10/100
-  **5,83**



AY 7450-BI PRINT WHITE

T-Shirt girocollo, manica corta, colletto in costina misto spandex da 1,5 cm con cucitura ribattuta, nastro di rinforzo da spalla a spalla, struttura tubolare. Busta per confezionamento non inclusa.

-  Cotone - 150 g/mq
-  XS - S - M - L - XL - XXL
3XL - 4XL - 5XL
-  10/100
-  **4,93**





BI



T-SHIRT BAMBINO
COTONE JERSEY





AY 7485 SUNSET KIDS

T-shirt bambino cotone jersey pettinato girocollo manica corta, colletto in costina con cucitura ribattuta sul davanti, nastro di rinforzo da spalla a spalla. Priva di busta per confezionamento.

-  Cotone - 150 g/mq
-  XS (3/4) - S(5/6) - M (7/8) - L(9/10) XL(11/12) XXL(13/14)
-  5/100
-  **5,74**

AY 7485-BI SUNSET KIDS WHITE

T-shirt bambino cotone jersey pettinato girocollo manica corta, colletto in costina con cucitura ribattuta sul davanti, nastro di rinforzo da spalla a spalla. Priva di busta per confezionamento.

-  Cotone Jersey - 150 g/mq
-  XXS(1/2 ANNI) - XS (3/4 ANNI) S(5/6) - M (7/8) - L(9/10) XL(11/12) XXL(13/14)
-  5/100
-  **4,97**





NE



BL



RY



VE



RO



BI

T-SHIRT SUNRISE





CUCITURE STRECH

Rinforzi Su Spalle







AY 7465 SUNRISE

T-shirt da uomo girocollo manica corta, colletto in costina misto spandex da 1.5 cm con cucitura ribattuta sul davanti, nastro di rinforzo da spalla a spalla in colore a contrasto visibile nel colletto, cuciture stretch, cucita lateralmente. 100% Cotone.

-  Cotone - 190 g/mq
-  XS - S - M - L - XL - XXL - 3XL
-  5/100
-  **8,73**

AY 7465-BI SUNRISE WHITE

T-shirt da uomo girocollo manica corta, colletto in costina misto spandex da 1.5 cm con cucitura ribattuta sul davanti, nastro di rinforzo da spalla a spalla in colore a contrasto visibile nel colletto, cuciture stretch, cucita lateralmente. 100% Cotone.

-  Cotone - 190 g/mq
-  XS - S - M - L - XL - XXL - 3XL 4XL - 5XL
-  5/100
-  **7,70**

BL



RY



NE



BI

FLAG UOMO

T-SHIRT

colletto

TRICOLORE

AY 7453 FLAG

T-shirt uomo, 100% cotone pettinato, colletto e bordo maniche in Rib con tricolore, struttura tubolare, collo nastrato tricolore.

i Cotone - 150 g/mq

o S - M - L - XL - XXL - XXXL

u 5/100

e 11,96



SM



RY



BL



NE



RO



FX



BI

T-SHIRT LADY

COLLO a "V"

AY 7464 V-NECK LADY

T-shirt collo a V manica corta sfiancata da donna, colletto in costina misto spandex da 1,5 cm con cucitura ribattuta sul davanti, nastro di rinforzo da spalla a spalla in colore a contrasto visibile nel colletto, cuciture stretch, cucita lateralmente.

 Cotone Jersey - 150 g/mq

 XS - S - M - L - XL

 5/100

 7,37



BL



SM



NE



ML



BI



RO



AR



RY

T-SHIRT UOMO

COLLO a "V"

AY 7466 V-NECK

T-shirt da uomo collo a V manica corta, colletto in costina misto spandex da 1,5 cm con cucitura ribattuta sul davanti, nastro di rinforzo da spalla a spalla in colore a contrasto visibile nel colletto, cuciture stretch, struttura tubolare.

i Cotone - 150 g/mq

o S - M - L - XL - XXL - XXXL

u 5/100

€ 7,37



NE/SM



SM/NE



BI/SM



BL/RV



RV/BL



AY 7458 CORPORATE

T-shirt bicolore, taschino al petto con porta penna, cuciture del collo coperte e nastro di rinforzo laterale.



Cotone 60% Poliestere 40%
165 g/mq



XS-S-M-L-XL-XXL-3XL-4XL-5XL



5/50



14,44

T-SHIRT CORPORATE BICOLORE

con Taschino

RETRO



RO/SM









RUNNER

Uomo

T-SHIRT
SPORTIVA

AY 7475 RUNNER

T-shirt da uomo tecnica-sportiva con manica raglan, doppia cucitura laterale per una migliore vestibilità, nastratura al collo.

-  Poliestere dry-tech - 150 g/mq
-  S - M - L - XL - XXL - 3XL
-  1/50
-  **8,25**

Manica Raglan

VF









BI



AY 7500 PINETA

T-shirt uomo manica lunga. In cotone 100% jersey, girocollo a costina, nastro di rinforzo alto 2,3cm da spalla a spalla, cucitura ribattuta sul davanti del collo, struttura tubolare che assicura la indeformabilità del capo.

-  Cotone - 165 g/mq
-  S - M - L - XL - XXL - XXXL
-  5/50
-  € **12,79**







PINETA

**T-SHIRT
UOMO
MANICA
LUNGA**

**STRUTTURA
TUBOLARE**

AY 7501 PINETA LADY

T-shirt girocollo manica lunga da donna, colletto e polsino in costina misto spandex con cucitura ribattuta sul davanti, nastro di rinforzo da spalla a spalla, cucitura laterale per una migliore vestibilità.

-  Cotone Jersey - 165 g/mq
-  S - M - L - XL
-  5/50
-  € 12,79



PINETA



T-SHIRT DONNA MANICA LUNGA *Misto Spandex*

BI



NE



BI



RY



RO



AY 7493 SHORE

Canotta uomo, spalla larga. Girocollo a costina rinforzata, nastro di rinforzo interno da spalla a spalla.

 Cotone - 150 g/mq

 S - M - L - XL - XXL

 5/100

 8,05



CANOTTA
UOMO
SPALLA
LARGA





CANOTTA
DONNA
 taglio
 sfiancato



AY 7496
LOOK

Canotta donna, cotone. Taglio sfiancato.

 Cotone - 190 g/mq

 S - M - L - XL

 5/100

 **12,38**

BI



NE



RO



TU



VM



CANOTTA ANDRÈ

stampa a
sublimazione

AY 7491

CANOTTA ANDRÈ

Canotta tecnica con spalline, tessuto traspirante facile da lavare e asciugare 100% poliestere piquet, adatto alla sublimazione. Cucitura angolare per migliorare la vestibilità, Etichetta rimovibile.



Poliestere Piquet - 140 g/mq



S - M - L - XL - XXL



10/100



5.76



POLO

promosolution
2021|2022

**AY 7440
VENICE**

Polo Uomo 3 bottoni in tinta, cotone piquet, mezza manica, collo e giro maniche a costina rinforzata, spacchi laterali, 100% cotone piquet pettinato, colori reattivi.

i Cotone Piquet pettinato - 200 g/mq

o XS - S - M - L - XL - XXL - XXXL
(colore Blu, Bianco, Arancione, Royal, Grigio Melange, Nero e Smoke disponibili anche 4XL - 5XL)

g 5/50

€ 16,26



POLO UOMO COTONE PIQUET

SPACCHETTI LATERALI







BA



AY 7439 VENICE LADY

Polo 4 bottoni mezza manica, cotone piquet, collo e giromanica a costina rinforzata, spacchi laterali, colori reattivi, taglio sfiancato.

-  Cotone Piquet - 200 g/mq
-  S - M - L - XL
-  5/50
-  **16,26**

POLO DONNA

4 BOTTONI

taglio
sfiancato



POLO

MANICA CORTA







TRE BOTTONI



RY

AY 7404 ROME

Polo a manica corta con 3 bottoni in tinta effetto perlato, spacchetti laterali, cuciture del collo coperte con nastro in tinta.

-  Cotone Piquet - 180 g/mq
-  XS - S - M - L - XL - XXL - 3XL
(4XL - 5XL disponibili solo su colori Bianco-Blu-Royal-Nero-Smoke)
-  5/50
-  **14,18**

RO



AR



JG



BL



NE



SM



ML



BI



POLO COMPANY

BICOLORE



POLO

NE/SM



BI/SM



SM/NE



RY/BL



BL/RV



RETRO



*con Taschino
Portapenna*

RO/SM



AY 7575 COMPANY

Polo bicolore a manica corta con 3 bottoni in tinta, taschino al petto con portapenna, bordo maniche a costine, spacchetti laterali, cuciture del collo coperte.



Cotone 60% Poliestere 40%
230 g/mq



XS-S-M-L-XL-XXL-3XL-4XL-5XL



5/50



28,46

SG



BL



ML



BI



POLO
PONTASCHINO

PIQUET DI
ALTA QUALITA'

**AY 7412
PRESTIGE**

Polo a manica corta a 4 bottoni in tinta, colletto modello camicia, taschino frontale, inserti in Oxford celeste su interno collo, spacchetti laterali e nella apertura frontale, 100% cotone piquet finissimo pettinato di altissima qualità.

i Cotone Piquet - 190 g/mq

o S - M - L - XL - XXL - XXXL

o 5/25

€ 27,23



BL



BA



BI



HC



EG



GLAMOUR LADY

5 BOTTONI
POLO CON TASCHINO
TAGLIO SFIANCATO

AY 7413
GLAMOUR LADY

Polo taglio sfiancato manica corta a 5 bottoni in tinta, colletto modello camicia, inserti in popeline celeste su interno collo, spacchetti laterali e nella apertura frontale 100% cotone piquet finissimo pettinato di altissima qualità.



Cotone Piquet - 190 g/mq



S - M - L - XL



5/25



27,23



BL/BI



AR/BI



VI/BI



RO/BI



NE/BI



POLO UOMO

3 Bottoni

COLLO e MANICA
A CONTRASTO

ML/BL



BI/BL



RY/BI



AY 7433 CAMBRIDGE

Polo Uomo, 3 bottoni mezza manica, collo e giromanica a contrasto, spacchi laterali, interno collo in oxford, occhielli sotto braccio.

i Cotone jersey - 175 g/mq

o S - M - L - XL - XXL - XXXL

g 5/25

€ 27,23



POLO DONNA

SPACCHI LATERALI
OCCHIELLI
SOTTOBRACCIO

6 Bottoni



NE/BI



BI/BL



RY/BI



BL/BI



AR/BI



RO/BI

AY 7430 LEEDS

Polo Donna, 6 bottoni mezza manica, colletto e bordo maniche in rib con riga contrasto, spacchi laterali, interno collo in oxford, interno patta bottoni in oxford, occhielli sotto braccio.

i Cotone jersey - 175 g/mq

◐ S - M - L - XL

⚙ 5/25

€ 27,23





RY



BL



NE



SM





POLO UOMO

Tintura reattiva

MANICHE COLLO E
SPACCHETTI
A CONTRASTO

AY 7414 MEMPHIS

Polo Uomo manica corta a tre bottoni in tinta ad effetto perlato, colletto da un lato in tinta dall'altro lato con colori a contrasto a fasce, visibile solo se alzato, interno abbottonatura collo e spacchetti laterali con contrasto, bordo manica dx con fine inserto nei colori del collo, bordo manica a costine, cuciture del collo coperte con nastro a contrasto, nastro di rinforzo laterale, 100% cotone jersey pettinato tintura reattiva.

-  Cotone jersey - 175 g/mq
-  S - M - L - XL - XXL - XXXL
-  5/25
-  27,23

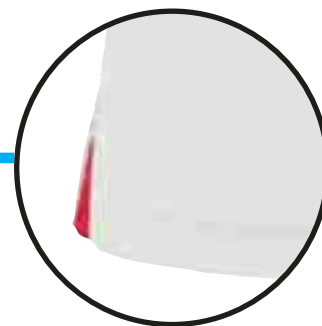

BI



AY 7415 MEMPHIS LADY

Polo Donna, sfiancata manica corta a sei bottoni in tinta ad effetto perlato, colletto da un lato in tinta dall'altro lato con colori a contrasto a fasce, visibile solo se alzato, interno abbottonatura collo e spacchetti laterali con contrasto, bordo manica dx con fine inserto nei colori del collo, bordo manica a costine, cuciture del collo coperte con nastro a contrasto, nastro di rinforzo laterale. 100% cotone jersey pettinato tintura reattiva.

i Cotone jersey - 175 g/mq

◐ S - M - L - XL

👕 5/25

€ 27,23



MEMPHIS LADY

6 Bottoni

MANICHE, COLLO
E SPACCHETTI
A CONTRASTO



NE



SM



BL



RY





RY/BI

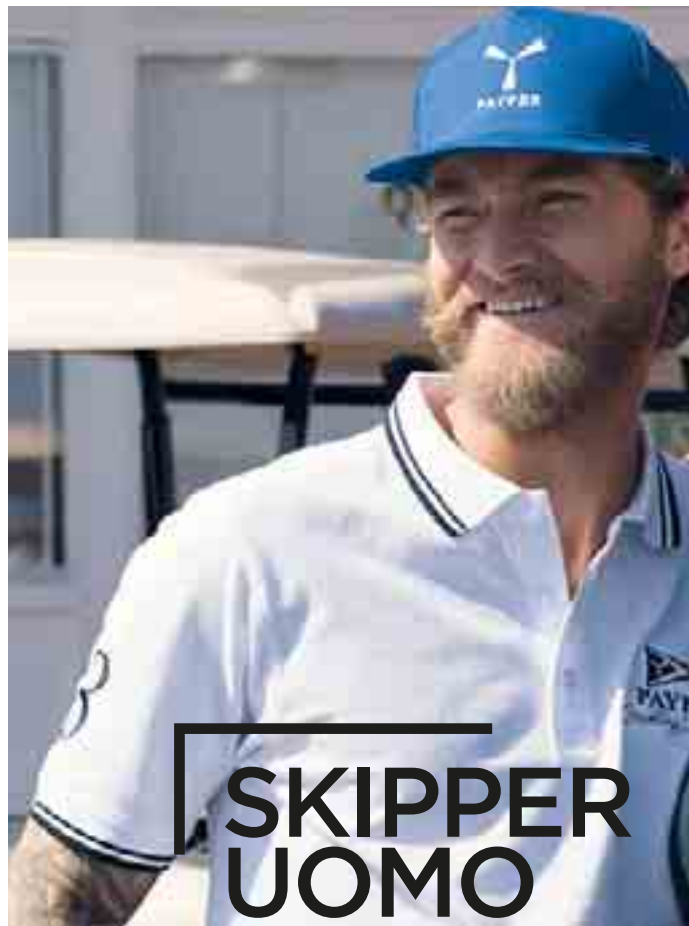

SKIPPER UOMO

IN PIQUET
3 BOTTONI

colori reattivi

AY 7438 SKIPPER

Polo Uomo, 3 bottoni mezza manica, collo e giromanica a contrasto, spacchi laterali, 100% cotone piquet pettinato, colori reattivi.

i Cotone Piquet - 210 g/mq

o S - M - L - XL - XXL

o 5/25

€ 22,90





SKIPPER LADY

TAGLIO
SFIANCATO
5 BOTTONI

colori reattivi

NE/BI



GR/AR



BL/BI



BI/BL



RO/BI



RO/BI



AY 7437 SKIPPER LADY

Polo Donna 5 bottoni mezza manica, collo e giromanica a contrasto, spacchi laterali, taglio sfiancato, 100% cotone piquet pettinato, colori reattivi.

i Cotone Piquet - 210 g/mq

o S - M - L - XL

u 5/25

€ 22,90





NE



AY 7421 NATION

Polo Uomo a manica corta a tre bottoni in tinta ad effetto perlato, colletto da un lato in tinta, dall'altro lato a contrasto con tricolore visibile solo se alzato, bordo manica dx con fine inserto tricolore in contrasto, bordo manica a costine, spacchetti laterali con tricolore, cuciture del collo coperte con nastro in jersey tricolore, nastro di rinforzo laterale. 100% cotone piquet pettinato tinto in filo a 60° con colori reattivi.



ML







BI

POLO UOMO NATION

3 bottoni

SPACCHI LATERALI
RETRO COLLETO **TRICOLORE**

-  Cotone Piquet - 210 g/mq
-  S - M - L - XL - XXL - XXXL
-  5/25
-  **28,46**



BL



RO



VM



RY



AY 7422 NATION LADY

Polo Donna sfiancata a manica corta a 5 bottoni in tinta ad effetto perlato, colletto da un lato in tinta, dall'altro lato a contrasto con tricolore visibile solo se alzato, bordo manica dx con fine inserto tricolore in contrasto, bordo manica a costine, spacchetti laterali con tricolore, cuciture del collo coperte con nastro in jersey tricolore, nastro di rinforzo laterale. 100% cotone piquet pettinato tinto in filo a 60° con colori reattivi.

i Cotone Piquet - 210 g/mq

o S - M - L - XL

u 5/25

e 28,46



POLO DONNA NATION

5 bottoni

TAGLIO SFIANCATO
RETRO COLLETO **TRICOLORE**







NAUTIC LADY



NAUTIC UOMO

AY 7418 NAUTIC LADY

Polo Donna, 6 Bottoni, manica corta, colletto con righe a contrasto interne e righe fluorescenti esterne, spacchetti e cuciture collo coperte con nastro fluo.

-  Cotone Jersey - 160 g/mq
-  S - M - L - XL
-  5/50
-  25,58



6 Bottoni





NASTRO FLUO SU COLLO E SPACCHETTI



3 Bottoni

AY 7416 NAUTIC

Polo Uomo 3 Bottoni, manica corta, colletto con righe a contrasto interne e righe fluorescenti esterne, spacchetti e cuciture collo coperte con nastro fluo.

-  Cotone Jersey - 160 g/mq
-  S - M - L - XL - XXL - XXXL
-  5/50
-  25,58





3bottoni





VENICE *KIDS*

SPACCHETTI
LATERALI
CUCITURE
STRECHT



AY 7489 VENICE KIDS

Polo da bambino a manica corta con 3 bottoni in tinta effetto perlato, colletto e bordo manica a costine, spacchetti laterali, cuciture del collo coperte con nastro a contrasto, cuciture stretch, nastro di rinforzo laterale, rinforzo sagomato retrocollo.

-  Cotone - 200 g/mq
-  S(5/6) - M(7/8) - L(9/10)
XL(11/12) - XXL(13/14)
-  5/50
-  **15,30**





FLORENCE
KIDS
**MANICA
 LUNGA
 3 BOTTONI**

**AY 7514
 FLORENCE KIDS**

Polo a manica lunga con apertura a 3 bottoni in tinta, spacchetti laterali e lunetta dietro collo.

i Cotone - 210 g/mq

o S(5/6) - M(7/8) - L(9/10)
 XL(11/12) - XXL(13/14)

o 5/50

€ 20,21





RY



POLO

ITALIA
COLLO E
GIROMANICA
TRICOLORE

colori reattivi

AY 7434
ITALIA

Polo 3 bottoni mezza manica, collo e giromanica con rigatura tricolore a contrasto, spacchi laterali, colori reattivi.

-  Cotone Piquet - 210 g/mq
-  XXS - XS - S - M - L - XL - XXL - XXXL
(Blu Navy, Bianco, Rosso, Royal, Nero disponibili anche in 4XL e 5XL)
-  5/25
-  **22,69**





BI

POLO UNISEX





COLLO E
POLSINO
TRICOLORE

3 Bottoni



AY 7505 AVIAZIONE

Polo Unisex manica lunga a 3 bottoni in tinta, collo e polsino con fine profilo tricolore in contrasto, polsino a costine, spacchetti laterali, cuciture del collo coperte, nastro di rinforzo laterale. Materiale: 100% cotone piquet pettinato tinto in filo a 60° con colori reattivi.

-  Cotone Piquet - 210 g/mq
-  S - M - L - XL - XXL - XXXL - 4XL - 5XL
-  5/25
-  € 25,99

POLO

NE



BI



SM



VE



ML



BL



RY



RO



AR



POLO FLORENCE

UOMO MANICA LUNGA

Cotone Piquet



AY 7515 FLORENCE

Polo Uomo manica lunga in cotone piquet con apertura a 3 bottoni in tinta, spacchetti laterali e lunetta dietro collo.



Cotone Piquet - 210 g/mq



S - M - L - XL - XXL - 3XL - 4XL - 5XL



5/50



24,55



AR

POLO FLORENCE LADY

MANICA
LUNGA
IN PIQUET

4 Bottoni



AY 7516 FLORENCE LADY

Polo Donna manica lunga in cotone piquet, con apertura a 4 bottoni in tinta, spacchetti laterali e lunetta dietro collo.

i Cotone Piquet - 210 g/mq

◐ XS - S - M - L - XL

☺ 5/50

€ 24,55

NE



RO



BL



RY



BI

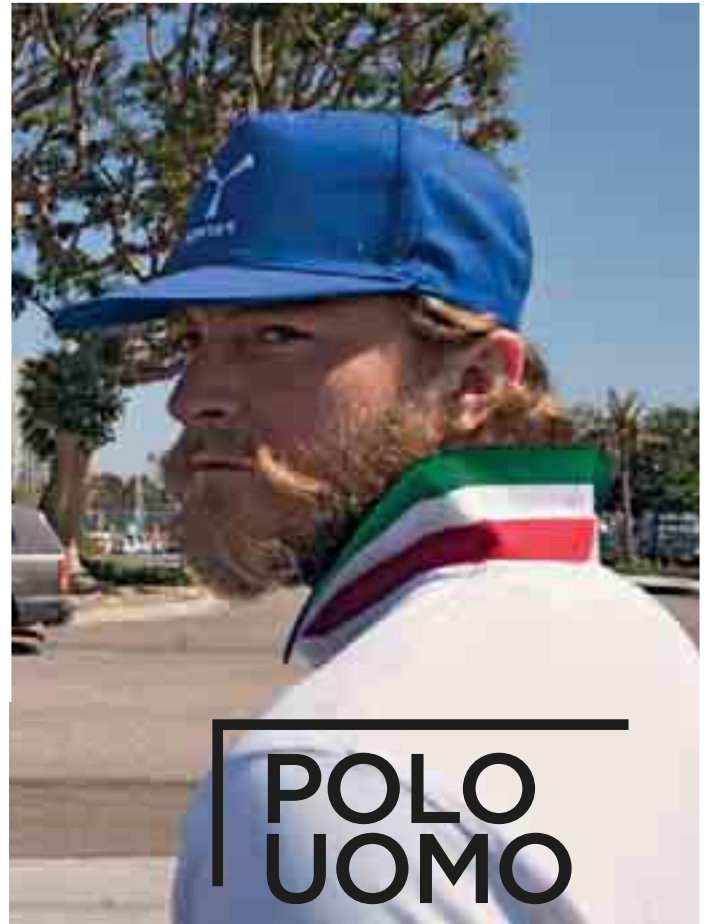

POLO UOMO

MANICA LUNGA
3 BOTTONI

*tricolore su
retro colletto*

AY 7509 LONG NATION

Polo Uomo manica lunga 3 bottoni, 100% cotone nido d'ape, colletto in tinta da un lato e tricolore dall'altro, spacchetti laterali, polsini elasticizzati.

i Cotone - 210 g/mq

o S - M - L - XL - XXL - XXXL

o 5/25

€ 32,59





FELPE

promosolution
2021|2022

NE



SM



BI



BL



RY



VE



RO



ML

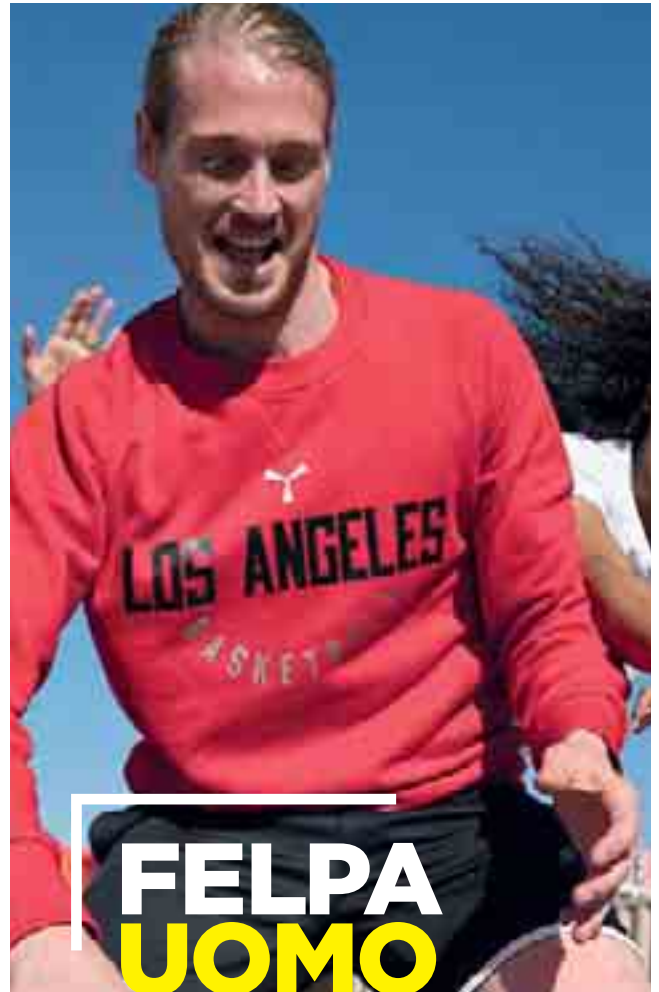

FELPA
UOMO

MANICA
RAGLAN

*disponibile anche
Mistral Lady*

AY 7521
MISTRAL+

Felpa Girocollo, manica raglan, cucitura estetica a V al collo, polsini e vita in costina elasticizzata, cuciture rinforzate. Disponibile anche in versione donna con taglio sfiancato: **MISTRAL LADY**



Cotone 70% + Poliestere 30%
300 g/mq



S - M - L - XL - XXL - 3XL



5/20







30,93



**AY 7524
NEW ORLEANS**

Felpa da uomo, girocollo, manica a giro, polsini e vita in costina elasticizzata, cuciture rinforzate.

-  Cotone 55% + Poliestere 45%
260 g/mq
-  XS-S-M-L-XL-XXL-3XL-4XL-5XL
-  5/20
-  **19,12**



GIROCOLLO
FELPA
UOMO

*polsini e vita
elasticizzati*

BL



RY



ML



SM



NE



FELPA UOMO

RO







GIROCOLLO MANICA A GIRO

cucitura V al collo



AY 7522 ORLANDO

Felpe da uomo, girocollo, cucitura estetica a V al collo, manica a giro, polsini e vita in costina elasticizzata, cuciture rinforzate.





-  Cotone 70% + Poliestere 30%
280 g/mq
-  XS - S - M - L - XL - XXL - 3XL
-  5/20
-  **23,60**

FELPA *KIDS*

cuciture rinforzate

AY 7523 ORLANDO KIDS

Felpe da bambino, girocollo, cucitura estetica a V al collo, manica a giro, polsini e vita in costina elasticizzata, cuciture rinforzate.

-  **Cotone 70% - Poliestere 30%**
280g/mq
-  3/4-4/5-5/6-7/8-9/10-11/12
-  5/20
-  **17,13**

BL



RY



BA



RO



AR



JG



GI



MIAMI

MEZZA ZIP

disponibile anche
MIAMI LADY

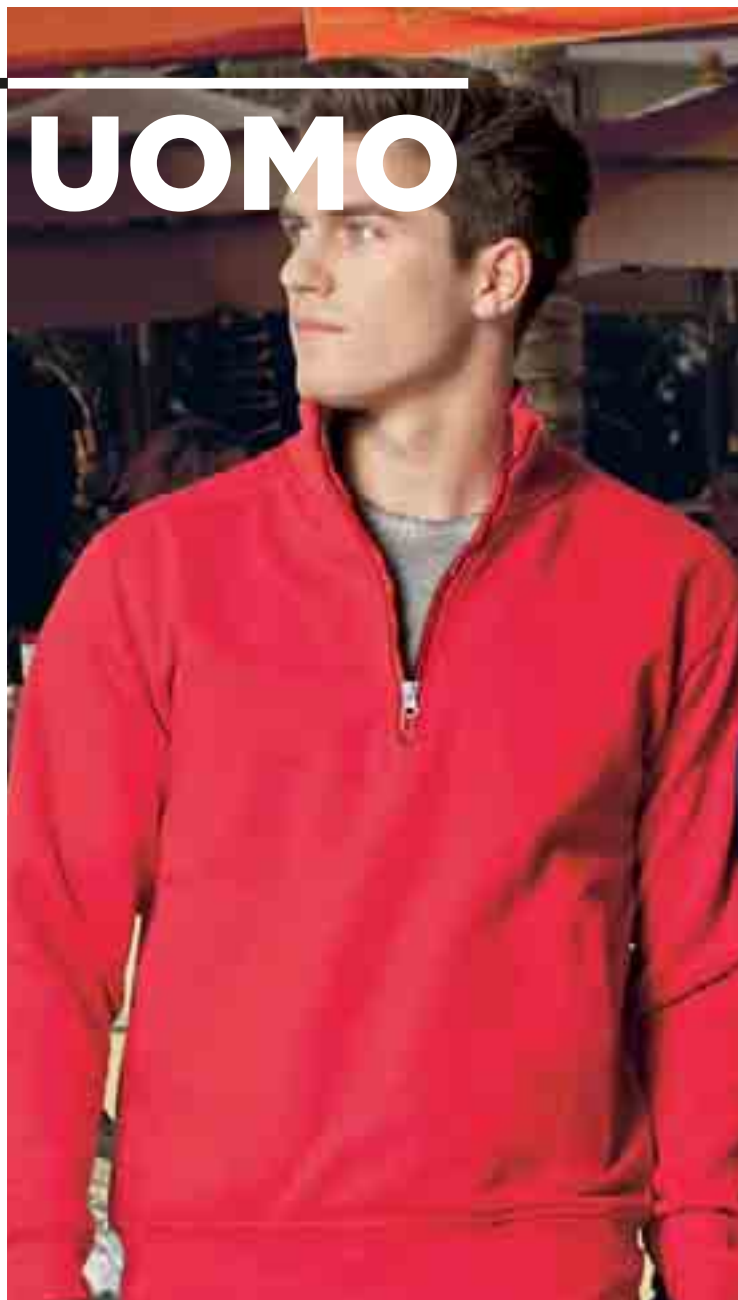

NE



BO



BL



SM



RO



RY



ML



GI



JG



BI



AR





VE



AY 7525 MIAMI+

Felpe a mezza zip con cursore in metallo, polsini e vita in costina elasticizzata, doppia cucitura al collo, alle maniche e in vita e nastro di rinforzo al collo. Disponibile anche in versione donna con taglio sfiancato: **MIAMI LADY**





-  **Cotone 70% + Poliestere 30%**
300 g/mq
-  **XS - S - M - L - XL - XXL - XXXL**
(Blu-Arancio-Nero-Royal-Smoke
Bianco-Melange disp. anche 4XL e 5XL)
-  **5/20**
-  **37,61**

FELPA UOMO



AY 7527 CANADA

Felpa mezza zip in tinta, polsini e vita in costina elasticizzata, cuciture rinforzate.

-  Cotone 70% + Poliestere 30%
260 g/mq
-  S - M - L - XL - XXL - XXXL
-  5/20
-  € 30,93

FELPE

mezza zip in tinta

NE



SM



ML



BL



RY



RO



AR



FELPA UOMO

cotone 100%

MANICA RAGLAN
MEZZA ZIP IN TINTA



AY 7528 AUSTIN

Felpe da uomo, mezza zip in tinta, in plastica con cursore in metallo ad effetto gommato, manica raglan, polsini e vita in costina elasticizzata, cucitura rinforzata.

i Cotone 100% - 330 g/mq

⊗ XS-S-M-L-XL-XXL-3XL

👤 1/20

€ 39,19



RY

BL



NE



SM



FELPA UOMO



PROFILI A CONTRASTO COLLO E TASCHE

COLLO, POLSINI
E VITA ELASTICIZZATI



RO



BL



RY



NE



GR

AY 7529 RIO

Felpa da uomo, mezza zip in plastica in colore a contrasto, cursore in metallo, profilo a contrasto nel colletto e alle tasche laterali. Manica a giro, collo, polsini e vita in costina elasticizzata, cuciture rinforzate.



Cotone 70% + Poliestere 30%
300 g/mq



XS-S-M-L-XL-XXL-3XL-4XL-5XL



5/20



48,48



FELPA UOMO

ZIP INTERA DOPPIO CURSORE



BI

polsini e vita
elasticizzata



AY 7545 PANAMA+

Felpe da uomo a manica raglan e zip intera in tinta, doppio cursore in metallo; due tasche con zip coperte, polsini e vita in costina elasticizzata, cuciture rinforzate. Disponibile anche in versione donna con taglio sfiancato "PANAMA LADY"

-  Cotone 70% + Poliestere 30%
300 g/mq
-  XS - S - M - L - XL - XXL - XXXL
(Blu-Royal-Bianco-Melange
Nero-Arancio disp. anche 4XL- 5XL)
-  5/20
-  47,30



NE



FELPA

**ZIP INTERA
CURSORE
IN METALLO**

rinforzo interno
collo

**AY 7542
HOUSTON**

Felpa con zip intera di plastica in tinta, cursore in metallo; polsini e vita in costina elasticizzata, cuciture rinforzate. Nastro di rinforzo interno collo in tinta.



Cotone 70% + Poliestere 30%
280 g/mq



XS - S - M - L - XL - XXL - 3XL



5/20



31,87

BL



RY



BI



NE



RO



GI



FELPA SYDNEY

zip intera
doppio cursore

AY 7530 SYDNEY

Felpe da uomo, zip intera SBS in plastica in colore a contrasto, con doppio cursore in metallo. Colletto in rib con profilo a contrasto anche alle tasche laterali, manica a giro, due tasche esterne con zip a contrasto, polsini e vita in costina elasticizzata. Cuciture rinforzate.



Cotone 70% + Poliestere 30%
300 g/mq



XS - S - M - L - XL - XXL - XXXL



5/20



53,54



BI



FELPA CON TRICOLORE SU ZIP E COLLO

2 TASCHE ESTERNE

AY 7532 NAZIONALE

Felpa a zip intera con contrasto tricolore e doppio cursore; colletto in rib con tricolore a contrasto all'interno, due tasche esterne, rib in vita, doppia cucitura al collo, alle maniche e in vita e nastro di rinforzo al collo.



Cotone 70% + Poliestere 30%
300 g/mq



XS - S - M - L - XL - XXL - 3XL



5/20



54,07



FELPA ATLANTA

disponibile anche ATLANTA LADY



RY

AY 7548 ATLANTA+

Felpe da uomo con manica raglan e cappuccio in tinta con coulisse in corda con cuciture in contrasto e anello in metallo, cucitura estetica a V al collo, tasche a marsupio, taschino con secur zip, polsini e vita in costina elasticizzata, cuciture rinforzate. Disponibile anche in versione donna con taglio sfiancato "ATLANTA LADY"

Garzato 70% + Poliestere 30%
300 g/mq

XS - S - M - L - XL - XXL - XXXL

5/20

49,30





BL



RY



NE



SM



ML

RO



FELPA

CON CAPPuccio

TASCHE A MARSUPIO

AY 7550 TORONTO

Felpe da uomo, cappuccio con coulisse in tinta, cucitura estetica a V al collo, tasche a marsupio, manica a giro, polsini e vita in costina elasticizzata, cuciture rinforzate. Nastro di rinforzo interno collo in tinta.



Cotone 70% + Poliestere 30%
280 g/mq



XS - S - M - L - XL - XXL - 3XL



5/20



31,87









FELPA MANICA RAGLAN E CAPPuccio

tasche a marsupio

disponibile anche
DALLAS LADY

AY 7535 DALLAS+

Felpe da uomo con manica raglan, zip intera con doppio cursore e cappuccio in tinta con coulisse e anello in metallo, cuciture in tinta con la felpe, tasche a marsupio con taschino con securzip, polsini e vita in costina elasticizzata. Cuciture rinforzate. Disponibile anche in versione donna con taglio sfiancato "DALLAS LADY".

-  Cotone 70% + Poliestere 30%
300 g/mq
-  XS - S - M - L - XL - XXL - XXXL
4XL - 5XL
-  5/20
-  **52,59**





RO

FELPA CON CAPPuccio

tasche a marsupio

**POLSINI E
VITA ELASTICIZZATI**

AY 7534 PORTLAND

Felpa da uomo, zip intera, cappuccio in tinta con coulisse e anello in metallo, cuciture in tinta con la felpa, tasche a marsupio, cuciture rinforzate, polsini e vita in costina elasticizzata. Nastro di rinforzo interno collo in tinta.

i Cotone 70% + Poliestere 30%
280 g/mq

o S - M - L - XL - XXL - 3XL

u 5/20

€ 36,71



RO



SM



NE



BL



FELPA UOMO

**BANDE
RIFLETTENTI
SULLE
SPALLE**

RY



WATER REPELLENT

AY 7554 WORK 2.0

Felpa da uomo, zip, intera SBS in plastica con cursore in metallo "autolock", due tasche con cerniera, una tasca multifunzione al petto con porta badge a scomparsa e patta di chiusura LOCK SYSTEM, bande riflettenti alle spalle, polsini e vita in costina elasticizzata, doppia cucitura al collo, alle maniche e in vita e nastro di rinforzo al collo. Trattamento del tessuto water repellent.



Cotone 70% + Poliestere 30%
300 gr/mq



XS - S - M - L - XL - XXL - 3XL 4XL - 5XL



5/20



78,18

NE



BL



SM



RY



BI



FELPA

CON CAPPuccio

zip doppio cursore

TASCHINO

SECUR-ZIP

**AY 7552
HAWAII+**

Felpe da uomo con manica raglan, zip intera con doppio cursore e cappuccio in tinta, coulisse con cuciture in tinta con la felpe e anello in metallo, tasche a marsupio con taschino con secur-zip, polsini e vita in costina elasticizzata. Cuciture rinforzate.



Cotone 80% + Poliestere 20%
260 g/mq



S - M - L - XL - XXL - XXXL



5/20



51,56



PANTALONE in felpa **LADY** 2 tasche

AY 7557 SEATTLE LADY

Pantalone da donna in felpa, rib elasticizzato in vita e a fondo gamba, coulisse bianca in corda con cuciture in contrasto e anelli in metallo, due tasche frontali con rib e cuciture rinforzate.

i Cotone 70% + Poliestere 30%
300 g/mq

o XS-S-M-L-XL

u 5/20

€ 46,41

PANTALONE in felpa **UOMO** 2 tasche

AY 7556 SEATTLE

Pantalone da uomo in felpa, rib elasticizzato in vita e a fondo gamba, zip con patta, coulisse bianca in corda con cuciture in contrasto e anelli in metallo, due tasche frontali con rib e un taschino dietro, patta con zip e cuciture rinforzate.

i Cotone 70% + Poliestere 30%
300 g/mq

o S - M - L - XL - XXL - 3XL

u 5/20

€ 46,41

*vita e fondo gambe
elasticizzati*





PILE

promosolution
2021|2022

PILE UOMO

MEZZA ZIP

ELASTICI

STRINGIPOLSO



AY 7560 DOLOMITI +

Pile a mezza zip con coulisse in vita, finitura al collo per un miglior posizionamento se portato sopra ad un altro capo dotato di colletto, elastici stringi polso, due tasche retinate internamente con zip di chiusura.

 Poliestere - 280 g/mq

 XS - S - M - L - XL - XXL - 3XL
4XL - 5XL

 5/20

 **36,11**



PILE UOMO

ZIP INTERA IN TINTA



SG



NE



VE



BL



RY

RO



AR



AY 7566 NEPAL

Pile full zip con manica a giro, zip in tinta in nylon con cursore singolo, due tasche con zip, elastico stringi polso e fondo non sagomato.



Poliestere - 280 g/mq



XS - S - M - L - XL - XXL - 3XL



5/20



28,16

NE/GR



GR/AR



BL/RV



RV/NE



RO/NE



VE/VA



PILE FIANCHI BICOLORE FULL ZIP

3 tasche



AY 7561 ASPEN +

Pile bicolore full zip, 3 tasche esterne con zip, elastici stringipolso, coulisse in vita, colletto interno e fianchi in contrasto. **Disponibile anche in versione donna con taglio sfiancato Aspen Lady**

i Pile Antipilling - 280 g/mq

o S - M - L - XL - XXL - 3XL

o 5/20

e 43,31



GIUBBINI

promosolution
2021|2022

NE



GR



BI



MA



BL



RY



RO



VM



AY 7260 NORTH 2.0

Giubbino in 100% nylon, con rib elasticizzato in vita e ai polsi, due tasche esterne con zip coperta; interno imbottito e micropile nel colletto e nella schiena, 1 tasca interna porta smartphone con cerniera e passaggio per cuffie, zip al petto e sul fondo schiena per agevolare stampe e ricami. Disponibile anche nella versione "NORTH LADY".



Nylon Taslon 228T - 105 g/mq



XS - S - M - L - XL - XXL - 3XL
(4XL - 5XL disponibili solo in Blu Navy e Nero)



1/10



72,19

GIUBBINO imbottito con tasca per SMARTPHONE



GIUBBINO IN NYLON

FULL ZIP 3 tasche esterne

**CAPPUCCIO
NEL COLLETTO**

BL



**AY 7257
NEW SPORT**

Giubbino in nylon, fullzip, interno in pile, 3 tasche esterne, 2 tasche interne, coulisse in vita, zip per agevolare stampe e ricami, cappuccio richiudibile nel colletto.

-  Nylon - 185 g/mq
-  M - L - XL - XXL
-  1/10
-  **39,90**



GIUBBINO UOMO

ZIP A CONTRASTO

VITA & POLSI
ELASTICIZZATI



BL



NE



AY 7255 NORTH R 2.0

Giubbino con rib elasticizzato in vita e ai polsi, cerniera in contrasto, due tasche esterne con zip coperta; interno imbottito e micropile nel colletto e nella schiena, 1 tasca interna con cerniera e passaggio per cuffie smartphone, zip al petto e sul fondo schiena per agevolare stampe e ricami.

i Nylon Taslon 228T - 105 g/mq

o XS - S - M - L - XL - XXL - 3XL

o 1/10

€ 77,96



GIUBBINO CON CAPPuccio

STRINGI POLSI
GOMMATI

AY 7254 SAILING R 2.0

Giubbino con cappuccio, elastico su fondo, polsi con elastico e stringi polsi gommati, cerniera in contrasto, due tasche esterne con zip coperta; interno imbottito e micropile nella schiena, 1 tasca interna con cerniera e passaggio per cuffie smartphone, zip al petto e sul fondo schiena per agevolare stampe e ricami.

 Nylon Taslon 228T- 105 g/mq

 XS - S - M - L - XL - XXL - 3XL

 1/10

 72,19



BL



NE

NE



BL



RY



GR







GIUBBINO MANICHE STACCABILI

tasche lock System

AY 7230 ESCAPE

Giubbino con maniche staccabili in pongee 240T, stringi polsi regolabile ed elastico, con cappuccio richiudibile nel colletto; due ampie tasche frontali LOCK SYSTEM, due tasche laterali, porta cellulare al petto. Interno imbottito e cerniera interna nella schiena per facilitare stampe/ ricami.

-  Poliestere 100% - 200 g/mq
-  XS - S - M - L - XL - XXL - 3XL
4XL - 5XL
-  1/10
-  **67,56**



GR



NE



BL

GIUBBINO UNISEX

*Cappuccio nel
colletto*

AY 7233 RENEGADE

Giubbino UNISEX con elastico in fondo e stringi polsi in pongee 240T, cappuccio richiudibile nel colletto; 2 ampie tasche frontali LOCK-SYSTEM, 2 tasche laterali, porta cellulare al petto, interno imbottito, cerniera nella schiena per facilitare stampe/ricami.

i Poliestere 100% - 200 g/mq

↻ XS - S - M - L - XL - XXL - 3XL

🔄 1/10

€ 57.36



BL/RO



GR/NE



NE/SG



BL/RY



GIUBBINO IMBOTTITO

CAPPUCCIO A SCOMPARSA

Maniche Staccabili

AY 7251 FIGHTER 2.0

Giubbino imbottito sagomato con cappuccio a scomparsa e maniche staccabili, due ampie tasche frontali con zip e due tasche con patta brevetto Lock System, entrambe inclinate per agevolare l'ingresso delle mani, una tasca al petto porta smart phone e anello portabadge, interno pile in contrasto su schiena e collo, una tasca interna, zip interna per agevolare stampe e ricami, due bande riflettenti su tasca al petto e schiena per una maggior visibilità/sicurezza.

-  Poliestere - Pongee Ripstop 240T
200 g/mq
-  XS - S - M - L - XL - XXL - 3XL
4XL - 5XL
-  1/10
-  **77,96**



GIUBBINO TRAPUNTATO

Maniche Staccabili
BANDE RIFLETTENTI

BL



GR



AY 7248 WARM 2.0

Giubbino trapuntato in Techno 80% Poliestere e 20% cotone, con maniche staccabili e con retro sagomato e imbottitura rifinita con fodera ad alta densità, interno colletto in pile. Ampia tasca al petto porta smart-phone, porta penne e due bande riflettenti, anello porta badge, due ampie tasche con zip sul davanti e una tasca interna.



Poliestere 80% cotone 20%
170 g/mq



S - M - L - XL - XXL - 3XL - 4XL - 5XL



1/10



64,54

SOFT-SHELL

MANICHE REGOLABILI CON VELCRO

3 tasche con Zip



AY 7228 GIACCA SOFT-SHELL

Giacca con cappuccio staccabile, coulisse elasticizzata, maniche con regolazioni a velcro, tasca sul petto, due tasche anteriori con zip. Outshell: 96% soft shell e poliestere 4% Elastane. Membrana TPU 8000 mm impermeabile, traspirabilità di 1000 g/mq/24h traspirabilità 3. Fodera in pile.

i Poliestere 96%
Elastane 4%

S S - M - L - XL - XXL - 3XL

1/10

€ 68,70





RO

SOFT-SHELL ERGONOMICO CAPPuccio AMOVIBILE



Bande riflettenti posteriori 3M



NE



SM



BL



RY



BI

AY 7231 PERFORMER 2.0

Giacca ergonomica da uomo, manica giro, zip intera SBS in plastica con cursore in metalloautolock, due tasche laterali con cerniera, una tasca multifunzionale al petto con porta badge a scomparsa e patta di chiusura LOCK SYSTEM, bande riflettenti 3M alle spalle, elastico e stringipolso in velcro, cappuccio amovibile e con coulisse in elastico regolabile con stopper.

i Poliestere 93%
Elastane 7% - 330 g/mq

o XS-S-M-L-XL-XXL
3XL-4XL-5XL

o 1/10

€ 98,18



SOFT-SHELL

TRATTAMENTO WATER REPELLENT

Zip lunga SBS



AY 7232 PERTH SOFT-SHELL

Giacca ergonomica da uomo a due strati con trattamento water repellent, manica a giro, zip lunga SBS nastrata, fine bordino elasticizzato ai polsi, 2 tasche laterali con zip.

i Poliestere - 280 g/mq

o S - M - L - XL - XXL - 3XL

o 1/20

€ 40,81



RY



BL



SG



RO



NE





SOFT SHELL CAPPuccio FISSO



AY 7223 GALE SOFT-SHELL

Giacca UNISEX in 100% poliestere, giacca ergonomica a zip intera, con cappuccio fisso, polsini regolabili con stringi polso, due tasche laterali con zip. Disponibile versione donna con taglio sfiancato Gale Lady

i Poliestere - 320 g/mq

o S - M - L - XL - XXL - 3XL

o 1/50

€ 69,76





SOFT-SHELL BICOLORE

CAPPUCCIO RICHIUDIBILE
NEL COLLETO

Polsini regolabili

RO/NE



AY 7237 STORM SOFT-SHELL

Giacca ergonomica da uomo bicolore, zip lunga SBS nastrata, cappuccio richiudibile nel colletto, polsini regolabili con stringi polso gommati e velcro, due tasche laterali con zip, una tasca al petto con porta badge a scomparsa, una tasca skipass al braccio, coulisse in vita. Una tasca interna e due zip per agevolare stampa e ricami al petto e alle spalle.

i Poliestere 93% + Elastan 7%
330 g/mq

o XS - S - M - L - XL - XXL
3XL - 4XL - 5XL

o 1/10

€ 98,18



SOFT-SHELL

MANICA RAGLAN - ZIP LUNGA

Cappuccio sagomato



BI/NE



AY 7235 EXTREME SOFT-SHELL

Giacca ergonomica da uomo, manica raglan, cappuccio sagomato con due cuciture e coulisse, zip lunga SBS nastrata, polsini regolabili con stringi polso gommati e velcro, fine bordino ai polsi e in vita, due tasche laterali con zip, una tasca al petto e una tasca al braccio sinistro.

i Poliestere - 280 g/mq

o XS - S - M - L - XL - XXL
3XL - 4XL - 5XL

o 1/10

€ 123,34



BL



RY



RO



NE



AY 7267 RAIN JACKET

Giacca cerata a collo alto con cerniera lunga. Cappuccio ripiegabile a scomparsa nel colletto con cordoncini. Due tasche con copritasca e cerniera. Polsini elastici. Parte inferiore con cordoncini regolabili e stopper.

 Poliestere - 70gr/mq

 S - M - L - XL - XXL

 1/50

 **20,01**

**GIACCA
CERATA**
ZIP INTERA
CAPPUCCIO A SCOMPARSA

Tasche con zip

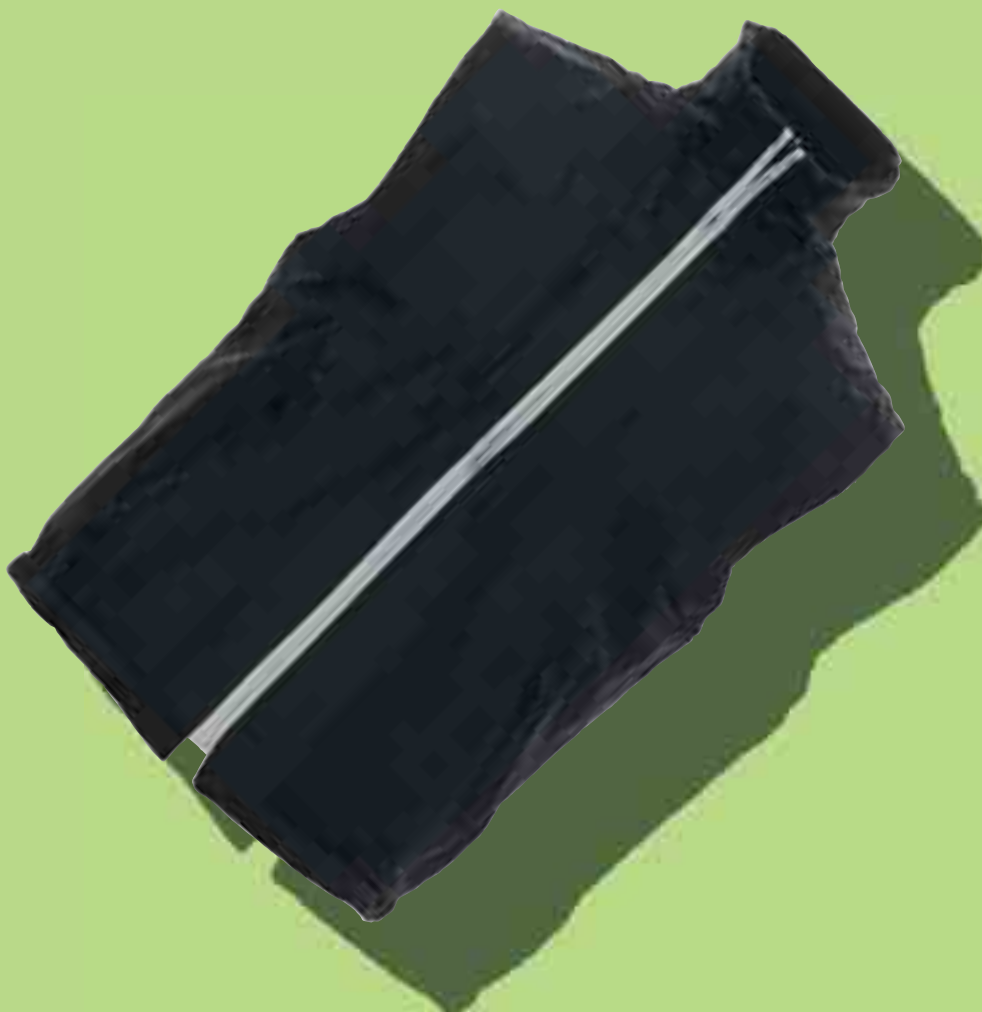

GILET

promosolution
2021|2022

450

GILET



BO



RO



AR



VE



BL-RO



BL-RY



RY



GILET IMBOTTITO

BANDE RIFLETTENTI AVANTI E DIETRO

interno pile in contrasto su schiena e collo

NE



GR-NE



GR-AR



AY 7201 MIG 2.0

Gilet imbottito sagomato, in, 2 ampie tasche frontali con zip e 2 tasche con patta brevetto Lock System entrambe inclinate per agevolare l'ingresso della mano, una tasca al petto porta smart phone e anello porta badge, interno pile in contrasto su schiena e collo, una tasca interna, zip interna per agevolare stampe e ricami, due bande riflettenti su tasca al petto e schiena per una maggior visibilità/sicurezza.



Pongee Ripstop 240t - Poliestere
200 g/mq



XS - S - M - L - XL - XXL - 3XL
(4XL - 5XL disponibili solo in Blu
Navy e Nero)



1/10



53,43

GILET UOMO

TASCHE FRONTALI LOCK-SYSTEM
+ PORTACELLULARE



NE

BL







SM



AY 7140 WANTED

Gilet sagomato con due tasche frontali LOCK SYSTEM, due tasche laterali, porta cellulare al petto; interno imbottito e con cerniera interna nella schiena per facilitare stampe/ricami.

-  Poliestere 100% - 200 gr/mq
-  XS - S - M - L - XL - XXL - 3XL
-  1/10
-  **41,01**



NE-VE



BL-RO



BL-RY



NE-SM



NE-GI



GILET IMBOTTITO INTERNO IN PILE

AY 7145 DAYTONA

Gilet imbottito sagomato con due tasche laterali e zip, una tasca al petto con zip, interno pile in contrasto.



Poliestere 100% - 200g/mq



S - M - L - XL - XXL - 3XL



1/10



51,55

NE/GR



SM/NE



BL/RV



RV/NE



RO/NE



GILET in POLIESTERE IMBOTTITO

Zip e Tasche coperte

AY 7200 MEMORY

Gilet da uomo in poliestere imbottito effetto piuma, zip in plastica coperta, due tasche esterne con zip coperte, interno in colore contrasto.

i Poliestere 240T - 56 g/mq

o XS - S - M - L - XL - XXL - 3XL

o 1/10

€ 40,84

GILET **UNISEX**

Imbottitura Trapuntata

*2 Tasche con Zip +
Tasca Portacellulare*

BL



NE







SM



AY 7150 STAR

Gilet trapuntato con retro sagomato e imbottitura trapuntata, rifinito con fodera ad alta densità, interno colletto in pile. Due ampie tasche con zip, tasca porta cellulare al petto e una tasca interna.

-  Poliestere - 160 g/mq
-  S - M - L - XL - XXL - 3XL
-  1/10
-  **31,87**



GILET TRAPUNTATO

PIPING REFLEX
AVANTI E DIETRO

2 Tasche con zip + Portacellulare

BL/RV



BL



RY



NE







GR



AY 7219 AIRSPACE 2.0

Gilet trapuntato con retro sagomato e imbottitura trapuntata e rifinita con fodera ad alta densità, interno colletto in pile. Piping reflex al petto e sulla schiena, ampia tasca al petto porta smartphone, anello porta badge, due ampie tasche con zip sul davanti e una tasca interna.

-  Poliestere 100% - 200 g/mq
-  S - M - L - XL - XXL - 3XL - 4XL - 5XL
-  1/10
-  **41,01**



GILET TRAPUNTATO RETRO SAGOMATO fodera alta densità



AY 7210 RADAR 2.0

Gilet trapuntato con retro sagomato, imbottitura trapuntata e rifinita con fodera ad alta densità, interno colletto in pile. Piping reflex al petto e sulla schiena, due ampie tasche con zip sul davanti e una tasca interna.

i Poliestere 100% - 180 g/m

o S - M - L - XL - XXL - 3XL

g 1/10

€ 34,22



AY 7227 GILET SOFT SHELL DONNA

Gilet con due tasche anteriori con zip più una tasca sul petto. Outshell. Membrana TPU 8000 mm impermeabile, traspirabilità di 1000 g/mq/24h 3. Fodera in pile.

i Soft-shell e poliestere
96% Elastane 4%

o S - M - L - XL - XXL

o 1/10

€ 39,19



NE

BL

GR



AY 7226 GLASGOW SOFT-SHELL UOMO

Gilet ergonomico a due strati e trattamento water repellent, con zip lunga, due tasche laterali con zip, una tasca al petto, coulisse in vita.

i Poliestere 80% - Cotone 20%
190 g/mq

o XS - S - M - L - XL - XXL
3XL - 4XL - 5XL

o 1/20

€ 39,19





GILET CON ELASTICO AL FONDO ZIP A CONTRASTO



2 tasche con zip coperte

BL



NE



RO



AY 7221 HORIZON R2.0

Gilet con elastico al fondo, cerniera in contrasto, due tasche esterne con zip coperta; interno, **non imbottito**, retinato, 1 tasca interna con cerniera e passaggio per cuffie smartphone, zip sul fondo per agevolare stampe e ricami.

i Taslon nylon- 105 g/mq

o XS - S - M - L - XL - XXL - 3XL

o 1/10

€ 47,44

460

GILET

BL



GILET **UNISEX**

ZIP A CONTRASTO

INTERNO IMBOTTITO

NE



AY 7185 SOUTH R 2.0

Gilet unisex, zip da 8mm a contrasto, elastico in vita, due tasche esterne con zip coperta. Interno: imbottito, micropile nel colletto e nella schiena, una tasca con cerniera e predisposizione per cuffie e cavo smartphone, zip al petto e sul fondo per agevolare stampe e ricami.

i Nylon 100% - 105 g/mq

o XS - S - M - L - XL - XXL - 3XL

o 1/10

€ 51,56



GILET UNISEX

REVERSIBILE

zip in plastica coperta

BL



NE



SM



AY 7180 SPEED

Gilet unisex reversibile, zip in plastica coperta con profilo reflex, coulisse in vita, tre tasche esterne. Interno: in pile, colletto in rib a maglia, due tasche e zip al petto per agevolare stampe e ricami.

 Poliestere - 180 g/mq

 S - M - L - XL - XXL - 3XL

 1/20

 45,38

GILET

MULTITASCHE IN COTONE

Fodera Dry-Tech

AY 7216 POCKET

Gilet Multitascalte in cotone e poliestere, composizione multitascalte esterne, chiusura con zip, fodera in dry-tech sulla schiena, bordino rifrangente sulle spalle e sulla schiena.

i Cotone 20% e Poliestere 80%
190 g/mq

o S - M - L - XL - XXL - XXXL

u 1/10

€ 32,59



SM



RO



KA



NE



BL













WORK

promosolution
2021|2022

AY 7340
GREMBIULE UOMO

-  Cotone 65%, poliestere 35%
260 g/mq.
-  100x86 cm
-  10/50
-  **11,97**

AY 7345
GREMBIULE DONNA

-  Cotone 65%, poliestere 35%
260 g/mq.
-  57x70 cm
-  10/80
-  **10,80**



GREMBIULE
UOMO



GREMBIULE
DONNA

AY 7347 GREMBIULE UOMO



Con finto Gilet con 2 tasconi.

-  Gabardine in Policotone 65%,
Poliestere 35% - 180 g/mq
-  100 x 86 cm
-  10/50
-  **16,65**



AY 7350 GREMBIULE DONNA

Con finto Gilet con 2 tasconi.





-  Gabardine in Policotone 65%,
Poliestere 35% - 180 g/mq
-  68 x 87 cm
-  10/50
-  **16,65**

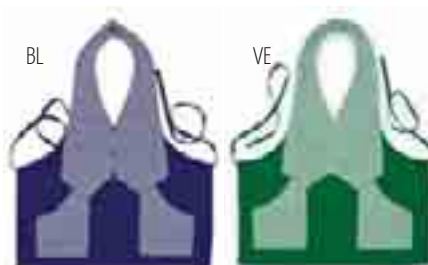

GREMBIULI IN STILE GILET UOMO e DONNA



AY 7358 GREMBIULE CONTASCOE

-  Cotone pesante 100%
210 g/mq.
-  67 x 84 cm
-  10/80
-  **8,94**

VE





NE

BO







AY 7365 GREMBIULE BIANCO

Con tascone.

-  Cotone pesante 100% - 195 g/mq.
-  65 x 80 cm
-  10/100
-  **5,37**



AY 7360
GREMBIULE
BARMAN
 Con 3 tasche

-  Cotone 100% - 210 gr/mq
-  56x36 cm
-  10/50
-  **5,67**



THERMO~~PRO~~

BASE LAYER TECHNOLOGY

PERFORMANCE

I Thermo Pro Base Layer sono ideati per le attività ad alta intensità nelle temperature da miti a fredde.

Thermo Pro Base Layer are the perfect match for intense activities in mild and cold temperatures.

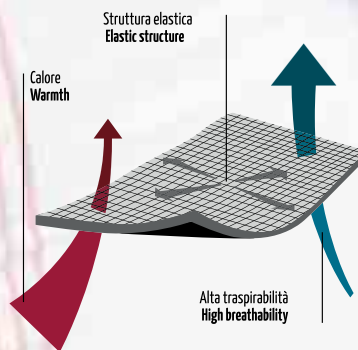

TECNOLOGIA / TECHNOLOGY

I Thermo Pro Base Layer garantiscono una termoregolazione costante grazie alle speciali tramature e alle eliche a rilievo che permettono una corretta aerazione. I tagli ergonomici assicurano un migliore adattamento alla fisionomia del corpo e libertà di movimento.

The Thermo Pro Base Layer ensure a constant thermoregulation thanks to their special weaves and to the embossed helixes which allow to have a correct ventilation. The ergonomic cuts ensure a better adaptation to the body appearance as well as more freedom of movement.

GAMMA TERMICA / THERMAL RANGE

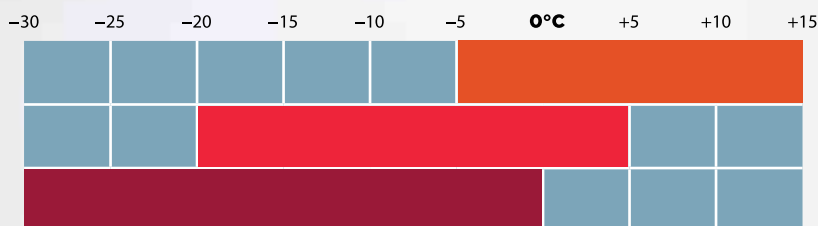



MAGLIA TERMICA UOMO



MANICHE RAGLAN
STRUTTURA TUBOLARE

AY 7285 THERMO PRO 160 SS

Maglia termica da uomo, girocollo, maniche corte raglan. Tessuto morbido ed elasticizzato, motivi ad elica in rilievo sui fianchi, per garantire una corretta traspirazione ed una costante termoregolazione. Collo, fondo e orli maniche a costine dello stesso materiale, per un miglior comfort. Struttura tubolare ergonomica per assicurare un perfetto adattamento alla fisionomia del corpo.

i 65% Poliammide + 35% Poliestere.
160 gr/mq

o S/M - L/XL - 2/3XL - 4/5XL

o 1/30

€ 26,81

NE



BI



RETRO



MAGLIA TERMICA UOMO



TESSUTO SPECIALE
TERMOREGOLANTE

AY 7286 THERMO PRO 280 SS

Maglia termica da uomo, girocollo, maniche corte raglan. Tessuto morbido ed elasticizzato, con speciali tramature sul petto e sulla schiena, motivi ad elica in rilievo sui fianchi, per garantire una corretta traspirazione ed una costante termoregolazione. Collo, fondo e orli maniche a costine dello stesso materiale, per un miglior comfort. Struttura tubolare ergonomica per assicurare un perfetto adattamento alla fisionomia del corpo.



65% Poliammide + 35% Poliestere.
8% Elastane - 280 gr/mq



S/M - L/XL - 2/3XL - 4/5XL



1/30



36,10

UOMO

DONNA

**AY 7287
THERMO PRO PANT**

Pantaloni termici da uomo, con vita e fondi a costina elasticizzata. Zigrinature sul fronte e sul retro, inserto sotto cavallo, per una perfetta vestibilità anatomica. Tramature sul davanti e retro gambe per garantire una corretta traspirazione nelle zone muscolari.

i 66% Poliammide + 26% Poliestere.
8% Elastane - 240 gr/mq

o S/M - L/XL - 2/3XL - 4/5XL

g 1/30

€ 27,63

PANTALONI TERMICI

**AY 7288
THERMO PRO LADY**

Pantaloni termici da donna, con vita e fondi a costina elasticizzata. Zigrinature sul fronte e sul retro, inserto sotto cavallo, per una perfetta vestibilità anatomica. Tramature sul davanti e retro gambe.

i 66% Poliammide + 26% Poliestere.
8% Elastane - 240 gr/mq

o XS/S - M/L - XL/2L

g 1/30

€ 27,63

AY 7290 THERMO PRO 240 LS

Maglia termica da uomo, girocollo, maniche lunghe raglan. Tessuto morbido ed elasticizzato, con speciali tramature sul petto e sulla schiena, motivi ad elica in rilievo sui fianchi, per garantire una corretta traspirazione ed una costante termoregolazione. Collo, fondo e orli maniche a costine dello stesso materiale, per un miglior comfort. Struttura tubolare ergonomica e speciale zigrinatura sui gomiti, per assicurare un perfetto adattamento alla fisionomia del corpo.

i 66% Poliammide + 26% Poliestere.
8% Elastane - 240 gr/mq

o S/M - L/XL - 2/3XL - 4/5XL

o 1/30

€ 39,40

NE



RETRO



MANICHE LUNGHE RAGLAN TESSUTO SPECIALE TERMO REGOLANTE

MAGLIA TERMICA UOMO

AY 7291 THERMO PRO 240 LD

Maglia termica da donna, girocollo, maniche lunghe raglan. Tessuto morbido ed elasticizzato, con speciali tramature sul petto e sulla schiena, motivi ad elica in rilievo sui fianchi, per garantire una corretta traspirazione ed una costante termoregolazione. Collo, fondo e orli maniche a costine dello stesso materiale, per un miglior comfort. Struttura tubolare ergonomica e speciale zigrinatura sui gomiti, per assicurare un perfetto adattamento alla fisionomia del corpo.

i 66% Poliammide + 26% Poliestere.
8% Elastane - 240 gr/mq

o XS/S - M/L - XL/2L

o 1/30

€ 39,40

NE



RETRO



MAGLIA TERMICA DONNA





NE



RETRO



**MAGLIA
TERMICA
UOMO**
**MANICHE
LUNGHE
RAGLAN**
SPECIALE
TESSUTO
TERMO
REGOLANTE

**AY 7289
THERMO PRO 280 LS**

Maglia termica da uomo, girocollo, maniche lunghe raglan. Tessuto morbido ed elasticizzato, con speciali tramature sul petto e sulla schiena, motivi ad elica in rilievo sui fianchi, per garantire una corretta traspirazione ed una costante termoregolazione. Collo, fondo e orli maniche a costine dello stesso materiale, per un miglior comfort. Struttura tubolare ergonomica e speciale zigrinatura sui gomiti, per assicurare un perfetto adattamento alla fisionomia del corpo.

i 65% Poliammide + 35% Poliestere.
280 gr/mq

o S/M - L/XL - 2/3XL - 4/5XL

o 1/30

€ 40,83







CAMICIA UOMO DA LAVORO

**TASCA TECNICA +
ASOLE PORTAPENNE**

AY 7315 SPECIALIST

Camicia uomo con vestibilità leggermente sfiancata, colletto modello italiano, davanti con cannoncino cucito a vista e bottone bianco effetto perlato, polso sagomato a due bottoni e un'asola; dietro con carrè e pines di ripresa; una tasca tecnica al petto chiusa da patta con bottone e due asole portapenne.

-  130 gr/mq
-  S - M - L - XL - XXL - 3XL - 4XL - 5XL
-  1/20
-  **23,78**







2 TASCHE

CAMICIA UOMO CHAMBRAY

AY 7337 CHAMBRAY

Camicia da Lavoro. Manica corta, 2 tasche con chiusura a bottoni.

-  Cotone Chambray - 135 g/mq
-  M - L - XL - XXL - 3XL
-  1/20
-  **21,06**



RO



SM



NE



BL



FELPA UOMO

BANDE RIFLETTENTI SULLE SPALLE

RY



WATER REPELLENT

AY 7554 WORK 2.0

Felpa da uomo, zip, intera SBS in plastica con cursore in metallo "autolock", due tasche con cerniera, una tasca multifunzione al petto con porta badge a scomparsa e patta di chiusura LOCK SYSTEM, bande riflettenti alle spalle, polsini e vita in costina elasticizzata, doppia cucitura al collo, alle maniche e in vita e nastro di rinforzo al collo. Trattamento del tessuto water repellent.



Cotone 70% + Poliestere 30%
300 gr/mq



XS - S - M - L - XL - XXL - 3XL 4XL - 5XL



1/20



78,17

PANTALONI WORKER



**AY 7318
WORKER SUMMER**

Pantalone unisex, estivo, elastici laterali e passanti in vita, chiusura con zip e bottone in plastica, due tasche anteriori a taglio classico, una tasca laterale LOCK SYSTEM, un porta metro, due tasche posteriori una aperta e una con patta e velcro, inserti ed impuntare a contrasto, bande reflex su tasca posteriore, cuciture triple.

i Cotone 100% - 210 gr/mq

1/20

XS - S - M - L - XL - XXL - 3XL - 4XL - 5XL

€ 38,03

**AY 7319
WORKER STRETCH**

Pantalone unisex, stretch, multistagione, elastici laterali e passanti in vita, chiusura con zip e bottone in plastica, due tasche anteriori a taglio classico, una tasca laterale LOCK SYSTEM, un porta metro, due tasche posteriori una aperta e una con patta e velcro, cuciture cavallo e interno gamba a triplo ago. Inserti ed impuntare a contrasto, bande reflex su tasca posteriore, cuciture triple.

i Cotone 98% + Elastan 2% - 300 gr/mq

1/20

XS - S - M - L - XL - XXL - 3XL - 4XL - 5XL

€ 44,61

**AY 7323
WORKER**

Pantalone Tecnico Pantalone multistagione con inserti e impunture a contrasto, elastici laterali e passanti in vita, chiusura con zip e bottone in plastica, cuciture cavallo e interno gamba a triplo ago, due tasche anteriori a taglio classico, la tasca laterale sx con LOCK SYSTEM, porta metro a dx; due tasche sul retro, una con patta di chiusura e una aperta con doppia banda rinfrangente di sicurezza.

i Cotone - 260 gr/mq

1/20

XS - S - M - L - XL - XXL - 3XL - 4XL - 5XL

€ 38,03

**AY 7320
WORKER WINTER**

Pantalone con inserti e impunture a contrasto, elastici laterali e passanti in vita, chiusura con zip e bottone in plastica, cuciture cavallo e interno gamba a doppio ago, due tasche anteriori a taglio classico, la tasca laterale sx con LOCK SYSTEM, porta metro a dx; due tasche sul retro, una con patta di chiusura e una aperta con doppia banda rinfrangente di sicurezza.

i Satin brushed 100% cotone 350 g/mq

1/20

XS - S - M - L - XL - XXL - 3XL - 4XL - 5XL

€ 45,17







**INSERTI E
IMPUNTURE
A CONTRASTO**



**AY 7307
WORKER WINTER REFLEX**





Pantalone unisex, invernale, con bande riflettenti in cat.1, elastici laterali e passanti in vita, chiusura con zip e bottone in plastica, due tasche anteriori a taglio classico, una tasca laterale LOCK SYSTEM, un porta metro, due tasche posteriori una aperta e una con patta e velcro, inserti ed impuntare a contrasto, bande reflex su tasca posteriore, cuciture doppie.

-  Cotone 100% - 350 gr/mq
-  XS - S - M - L - XL - XXL - 3XL 4XL - 5XL
-  1/20
-  € 45,17

RETRO

**AY 7308
WORKER REFLEX**

Pantalone unisex, multistagione, con bande riflettenti in cat.1, elastici laterali e passanti in vita, chiusura con zip e bottone in plastica, due tasche anteriori a taglio classico, una tasca laterale LOCK SYSTEM, un porta metro, due tasche posteriori una aperta e una con patta e velcro, inserti ed impuntare a contrasto, bande reflex su tasca posteriore, cuciture triple.

-  Cotone 100% - 260 gr/mq
-  XS - S - M - L - XL - XXL - 3XL 4XL - 5XL
-  1/20
-  € 45,26



NE



PANTALONI UNISEX ELASTICI IN VITA

BANDE RIFLETTENTI

SM



SM



NE



**AY 7325
CANYON**

Pantalone unisex, multistagione, elastici laterali e passanti in vita, chiusura con zip e bottone in metallo, due tasche anteriori a taglio classico e una tasca con zip, una tasca laterale LOCK SYSTEM, una doppia tasca lato sinistro porta metro, due tasche posteriori una aperta e una con patta e velcro. Insetti ed impuntare a contrasto, bande reflex su tasca posteriore, cucitura tripla interno gamba.

i Twill Cotone - 265 g/mq

o XXS - XS - S - M - L - XL - XXL 3XL - 4XL - 5XL

o 1/20

€ 38,03



PANTALONI UNISEX

MULTISTAGIONE

**AY 7309
WORKER TECH**

Pantalone unisex, multistagione con porta ginocchiere, elastici laterali e passanti in vita, chiusura con zip e bottone in plastica, due tasche anteriori a taglio classico, una tasca laterale LOCK SYSTEM, un porta metro e un porta smartphone, due tasche posteriori una aperta e una con patta e velcro, inserti ed impuntare a contrasto, bande reflex su tasca posteriore, cuciture triple.

i Poliestere 65% + Cotone 35%
265 g/mq

o XS - S - M - L - XL - XXL - 3XL 4XL - 5XL





o 1/20

€ 57,35



**AY 7326
ENGINE**

Pantalone con passanti ed elastico in vita, chiusura con zip e bottone. Cuciture cavallo e interno gamba a doppio ago, due tasche anteriori a taglio classico, porta metro laterale dx, una tasca posteriore con patta e velcro.





-  Cotone 100% - 260 gr/mq
-  XXS-XS-S-M-L-XL-XXL-3XL-4XL-5XL
-  1/25
-  € **24,40**



RETRO

**AY 7314
POWER**

Pantalone con passanti ed elastico in vita, chiusura con zip e bottone. Cuciture cavallo e interno gamba a doppio ago, due tasche anteriori a taglio classico, taschino porta monete, porta metro laterale dx, tasca laterale sx con patta di chiusura LOCK SYSTEM, due tasche posteriori di cui una con patta e velcro.

-  Cotone 100% - 260 gr/mq
-  XXS-XS-S-M-L-XL-XXL-3XL-4XL-5XL
-  1/25
-  € **26,72**

BL



BL



PANTALONI CON
CUCITURE A DOPPIO AGO

TASCA LATERALE

AY 7327 FOREST SUMMER

Pantalone da Lavoro Elastico in vita, 2 tasche anteriori, 2 tasche laterali, 2 tasche posteriori con chiusura in velcro, taschino portametro.

 Cotone Drill Ripstop 100% - 210 gr/mq

 1/20

 XS - S - M - L - XL - XXL - 3XL

 € 50,73



PANTALONI DA LAVORO

MULTITASCHE



AY 7332 FOREST

Pantalone da lavoro multitasche 100% IN COTONE drill 2 tasche anteriori a taglio classico, 2 tasconi a coscia laterali con patta e bottoni automatici, tasca SECUR-ZIP tasca portametro a scomparsa, 2 tasche posteriori a filo chiusura bottoni, passanti ed elastici in vita, cotone prelavato.

 Cotone - 280 gr/mq

 1/20

 XS - S - M - L - XL - XXL
(Blu disponibile anche in 3XL - 4XL)

 € 50,73

**AY 7322
WEST**

Pantalone multitasche uomo in taglio jeans, 1 tascone laterale LOCK SYSTEM con rinforzo interno, 1 tasca con zip, 1 porta metro, 1 porta smartphone, 1 porta martello, 1 taschino porta penne e cutter, chiusura con zip in metallo e bottone, passanti in vita, trattamento stone washed, effetto consumato e délavé; gamba diritta, cuciture filo grosso a contrasto ed a triplo ago interno gamba. DENIM STRETCH

- i** 72% Denim + 26% Pol + 2% Elastan
280-300 gr/mq
- o** 42-44-46-48-50-52-54-56/58-60/62
64/66-68/70-72/74
- u** 1/20
- €** 56,50



PANTALONI MULTITASCHE

TAGLIO JEANS

**AY 7321
SAN FRANCISCO**

Pantalone uomo in taglio jeans a cinque tasche, 1 porta metro a scomparsa, 1 taschino porta penne e cutter, chiusura con zip in metallo e bottone, passanti in vita, trattamento "stone washed", effetto consumato e délavé; gamba diritta, cuciture filo grosso a contrasto ed a triplo ago interno gamba.

- i** Denim Stretch 72% + 26% Pol
+ 2% Elastan · 280-300gr/mq
- o** 42-44-46-48-50-52-54-56/58
60/62-64/66-68/70-72/74
- u** 1/20
- €** 36,82



AY 7300 BERMUDA CARACAS

Bermuda uomo, elastici laterali e passanti in vita, chiusura con zip e bottone in plastica, due tasche anteriori a taglio classico, una tasca laterale LOCK SYSTEM, un porta metro, due tasche posteriori una aperta e una con patta e velcro, inserti ed impunture a contrasto, bande reflex su tasca posteriore, cuciture triple.

 Cotone 100% - 210gr/mq

 XS-S-M-L-XL-XXL-3XL-4XL-5XL

 1/20

 35,06

RETRO



SM



BERMUDA UOMO MULTITASCHE

BANDE REFLEX POSTERIORI

NE



KA



BL



KA



BL



MI



SM



RY



BERMUDA UOMO CLASSICO MULTITASCHE

AY 7302 BERMUDA RIMINI SUMMER

Bermuda uomo, elastici laterali e passanti in vita, chiusura con zip e bottone in metallo, due tasche anteriori a taglio classico, due tasche laterali con patta e bottoni automatici, una tasca con zip lato sinistro, un portametro a scomparsa lato destro, due tasche posteriori a filo con asola e bottone.

 Cotone 100% - 210 gr/mq

 XS-S-M-L-XL-XXL-3XL-4XL-5XL

 1/20

 43,31

RETRO



NE







PANTALONI & COMPLETI

ALTA VISIBILITÀ





**AY 7596
CHARTER WINTER**

Pantalone uomo, invernale, in alta visibilità bicolore con bande riflettenti, elastici laterali e passanti in vita, chiusura con zip e bottone in plastica, due tasche anteriori a taglio classico, tasca laterale LOCK SYSTEM, porta metro, due tasche posteriori una aperta e una con patta e velcro. Cuciture a contrasto, cavallo e interno gamba a triplo ago.

-  Poliestere 80% + Cotone 20%
295 gr/mq
-  S - M - L - XL - XXL - 3XL - 4XL - 5XL
-  1/20
-  € 51,75





**AY 7597
CHARTER**

Pantalone uomo, multistagione, in alta visibilità con bande riflettenti, elastici laterali e passanti in vita, chiusura con zip e bottone in plastica, due tasche anteriori a taglio classico, tasca laterale LOCK SYSTEM, porta metro, due tasche posteriori una aperta e una con patta e velcro. Cuciture a contrasto, cavallo e interno gamba a triplo ago.

-  Cotone 50% Poliestere 50%
250 gr/mq
-  S - M - L - XL - XXL - 3XL - 4XL - 5XL
-  1/20
-  € 48,46

**AY 7591
HI-VI RAINSET**

Completo antipioggia in alta visibilità con bande riflettenti, composto da giacca con zip, cappuccio richiudibile nel colletto, fondo manica dritto, retinatura sulla schiena. Pantalone con elastico in vita e due tasche. Imbusto singolo con zip.

-  Poliestere Spalmato Poliuretano 100%
130 g/mq
-  M - L - XL - XXL - 3XL
-  1/10
-  € 47,21

GILET

ALTA VISIBILITA'

MULTITASCHE CON
BANDE RIFRANGENTI**AY 7592****GILET ALTA VISIBILITA'**

Gilet in alta visibilità multitasche con bande rifrangenti, chiusura frontale con zip, due tasche frontali con patta di chiusura una tasca al petto con patta, taschino portapenna, anello per aggancio portabadge. Un portasmartphone e anello di aggancio per portabadge. Interno: imbottito, una tasca interna con velcro, cuciture termonastrate.

i Poliestere 100%

◐ S - M - L - XL - XXL - 3XL

👤 1/10

€ 16,65

GILET CERTIFICATO EN471 CON BANDE RIFRANGENTI

AR



GI

**AY 7225****GILET ALTA VISIBILITA'**

Certificato EN 471, chiusura con velcro.

i Poliestere 150 D

◐ M - XL - XXL

👤 1/50

€ 5,40

FELPA UOMO

ALTA VISIBILITÀ





CON CAPPUCCIO
E BANDE RIFLETTENTI



AR

AY 7582 LEADER

Felpe da uomo in alta visibilità con cappuccio e bande riflettenti, zip intera SBS con cursore in metallo autolock, polsini e vita in costina elasticizzata, due tasche frontali con zip coperta, una tasca multifunzione al petto con anello porta badge e patta di chiusura LOCK SYSTEM.

-  Poliestere 100% - 300 gr/mq
-  XS - S - M - L - XL - XXL - 3XL 4XL - 5XL
-  1/20
-  € 80,43



GI

AY 7583 SHINE SOFT SHELL

Giacca ergonomica da uomo bicolore in alta visibilità con bande 3M, manica raglan, cappuccio sagomato con due cuciture e coulisse, zip lunga SBS nastrata, polsini regolabili con stringi polso in velcro, due tasche laterali con zip, una tasca al petto, porta badge staccabile e richiudibile e una tasca al braccio sinistro.

i Poliestere 100% - 310 gr/mq

o S - M - L - XL - XXL - 3XL - 4XL - 5XL

o 1/10

€ 121,68



GIACCA ERGONOMICA BICOLORE

BANDE ALTA VISIBILITA' 3M

**MANICHE
RAGLAN**



AR



RETRO



GI



AR



GI



GIUBBINO BICOLORE

AY 7590 PADDOCK

Giubbino bicolore in alta visibilità con bande riflettenti, zip intera con patta, cappuccio richiudibile nel colletto, vita e polsini elasticizzati, due ampie tasche frontali con patta e velcro, portacellulare e anello di aggancio per porta badge. Interno: imbottito, una tasca con velcro, cuciture termonastrate.



Poliestere Spalmato Poliuretano
180 g/mq



S - M - L - XL - XXL - 3XL - 4XL - 5XL



1/10



69,92

**ALTA
VISIBILITA'**
**CAPPUCCIO
RICHIUDIBILE**
**INTERNO
IMBOTTITO**

PARKA BICOLORE ALTA VISIBILITA' BANDE RIFLETTENTI



AR



GI

RETRO



AY 7589 YARD

Parka fisso bicolore in alta visibilità con bande riflettenti, zip intera con patta, cappuccio richiudibile nel colletto, polsini in RIB elasticizzato, due tasche frontali con patta, un portasmartphone e anello di aggancio per portabadge. Interno: imbottito, una tasca interna con velcro, cuciture termonastrate.

i 100% Poliestere Spalmato Poliuretano,
300D Oxford 100% PI/Pu 190T
Taffetà. - 180 gr/mq

o S - M - L - XL - XXL - 3XL

u 1/10

€ 69,92



GETLINE



1 TOMAIA UPPER

Tomaia resistente, traspirante e impermeabile, in diversi materiali di altissima qualità e abbinamenti cromatici. Dotata di soffiotti in materiale coordinato, presenta travette di rinforzo e una comoda tallonetta antiscalzante ed antiabrasione nel tacco. La calzata è regolare, con sviluppo calibrato per ogni tipo di conformazione del piede.

Sturdy, breathable and waterproof upper; various high-quality materials and colour combinations. Coordinated bellows tongues material, it has reinforcement bartacks and a useful anti-slip and anti-abrasion heel support. The fit is regular, with a calibrated development for each foot type.

2 FODERA LINING

La fodera interna è interamente (compresa la punta) in nylon traspirante e resistente all'abrasione.

The lining is fully (including the toe-end) made of breathable nylon and resistant to abrasion.

3 OCCHIELLI METALFREE METAL-FREE EYELETS

I comodi occhIELLI metalfree favoriscono un'allacciatura rapida per mantenere il piede saldo, assicurando un sicuro effetto antidistorsione.

The practical metal-free eyelets facilitate a fast lacing in order to keep the foot firm, ensuring an anti-torsion effect.

4 PARATACCO HEEL GUARD

Compatto paratacco in pelle bycast con grana pampas idrorepellente, dotato di inserto riflettente.

Compact heel guard in bycast leather with water-repellent pampas grain and reflective panel.

5 TOP.ALU.CAP.

L'innovativo puntale in alluminio pressofuso, leggero e ultrasensibile agli impatti fino a 200 Joule. La tecnica dell'iniezione ad alte pressioni e temperature assicura il riempimento omogeneo dello stampo, per una robustezza e sicurezza sempre al top.

The innovative tip in die-cast aluminium, light and anti-static, it is highly resistant to impacts up to 200 Joule. The high pressure and temperature injection technique ensures consistent mould filling, for top-level sturdiness and safety.

6 PLANTARE ORTHOLITE® ORTHOLITE® ARCH SUPPORT

Il plantare Ortholite® X40 016 ESD estraibile è 100% traspirabile e mantiene un ambiente sano e asciutto all'interno della scarpa. Completamente lavabile, non compromette nel tempo l'ammortizzazione e la calzata.

The removable Ortholite® X40 016 ESD arch support is 100% breathable and keeps the inside of the shoe healthy and dry. Fully washable, it does not impair the cushioning and fit even over time.

7 SOLETTA ANTIPERFORAZIONE PERFORATION-PROOF INSOLE

Soletta in lamina tessile certificata antiperforazione, ad alto coefficiente di rinforzo e resistenza.

Textile insole certified against punctures with high reinforcement and resistance features.

8 SOTTOPUNTALE UNDER-TOE

Sottopuntale in policarbonato a ferro di cavallo per aumentare la resistenza allo schiacciamento.

Horseshoe-shaped under-toe in polycarbonate to increase crushing resistance.

9 SHANK ANTITORSIONE ANTI-TORSION SHANK

Cambrione o lamina stabilizzatrice antitorsione ultrasensibile in poliammide caricata con fibre sintetiche di rinforzo.

A highly-resistant polyamide shank or plate loaded with synthetic reinforcement fibres.

10 INTERSUOLA MID-SOLE

Intersuola con sagoma ortopedica realizzata in durevole poliuretano ultraleggero ESD EPAFLEX. È anti-idrolisi e con elevata resistenza alla compressione.

An orthopaedic-shaped mid-sole made in long-lasting ultra-light polyurethane ESD EPAFLEX. Anti-hydrolysis with high resistance to compression.

11 MASTER BALANCE

L'efficace sistema di ammortizzazione Master Balance in PU polietero ad alta tenacità e densità bilanciata ammortizza la trasmissione degli urti al tallone, per il mantenimento di una corretta postura in tutto il tempo di utilizzo della scarpa.

The effective Master Balance cushioning system in PU polyether, with high tenacity and balanced density, cushions shocks to the heels, in order to maintain a correct posture for all the time the shoe is worn.

12 SUOLA X TRAIL GRIP X TRAIL GRIP SOLE

Suola realizzata con l'esclusiva tecnologia Co.Bo. in TPU (poliuretano termoplastico espanso) ESD resistente sia alle basse che alle medio-alte temperature. Dotata di paratacco e parapunta, garantisce elevata stabilità grazie al grip perfetto antiscivolo adatto a tutte le superfici.

A sole created with the exclusive Co. Bo. technology in TPU (foamed thermoplastic polyurethane) ESD resistant both at low and medium-high temperatures. With both heel guard and tip guard it ensures high stability thanks to the non-slip grip suitable for all surfaces.





SCARPE DI SICUREZZA DA UOMO

IN PELLE S3



LOW PELLE

Scarpa di sicurezza bassa da uomo, tomaia in pelle idrorepellente e traspirante, fodera interna (per tutta la superficie interna) traspirante e resistente all'abrasione, 6+6 occhielli metalfree, paratacco in grana pampas con inserto riflettente, puntale in alluminio pressofuso, plantare estraibile Ortholite X40 016 ESD, soletta in lamina tessile certificata antiperforazione, cambrione antitorsione, sottopuntale a ferro di cavallo, intersuola in poliuretano ultraleggero ESD, ammortizzatore MASTER BALANCE in PU polietere ad alta tenacità e densità bilanciata, suola XTRAIL GRIP in TPU ESD con paratacco e parapunta.

 Tutto Fiore Bovino

 39 - 40 - 41 - 41,5 - 42 - 42,5 - 43 - 43,5 - 44 - 44,5 - 45 - 46 - 47 - 48

 1

 **SU RICHIESTA**



MID PELLE

Scarpa di sicurezza medium da uomo, tomaia in pelle idrorepellente e traspirante, fodera interna (per tutta la superficie interna) traspirante e resistente all'abrasione, 8+8 occhielli metalfree, paratacco in grana pampas con inserto riflettente, puntale in alluminio pressofuso, plantare estraibile Ortholite X40 016 ESD, soletta in lamina tessile certificata antiperforazione, cambrione anti-torsione, sottopuntale a ferro di cavallo, intersuola in poliuretano ultraleggero ESD, ammortizzatore MASTER BALANCE in PU polietere ad alta tenacità e densità bilanciata, suola XTRAIL GRIP in TPU ESD con paratacco e parapunta.

 Tutto Fiore Bovino

 39 - 40 - 41 - 41,5 - 42 - 42,5 - 43 - 43,5 - 44 - 44,5 - 45 - 46 - 47 - 48

 1

 **SU RICHIESTA**

CI



RO



NE



SM



SM/BI



TB



GI



SCARPE BASSE DI SICUREZZA DA UOMO

IN NABUK S3



LOW NABUK

Scarpa di sicurezza bassa da uomo, tomaia in pelle idrorepellente e traspirante, fodera interna (per tutta la superficie interna) traspirante e resistente all'abrasione, 6+6 occhielli metalfree, paratacco in grana pampas con inserto riflettente, puntale in alluminio pressofuso, plantare estraibile Ortholite X40 016 ESD, soletta in lamina tessile certificata antiperforazione, cambriante antitorsione, sottopuntale a ferro di cavallo, intersuola in poliuretano ultraleggero ESD, ammortizzatore MASTER BALANCE in PU polietere ad alta tenacità e densità bilanciata, suola XTRAIL GRIP in TPU ESD con paratacco e parapunta.



Fiore Bovino



39 - 40 - 41 - 41,5 - 42 - 42,5 - 43 -
43,5 - 44 - 44,5 - 45 - 46 - 47 - 48



1



SU RICHIESTA





SCARPE DI SICUREZZA MEDIUM DA UOMO



IN NABUK S3

**PUNTALE IN
ALLUMINIO**



MID NABUK

Scarpa di sicurezza medium da uomo, tomaia in pelle idrorepellente e traspirante, fodera interna (per tutta la superficie interna) traspirante e resistente all'abrasione, 8+8 occhielli metalfree, paratacco in grana pampas con inserto riflettente, puntale in alluminio pressofuso, plantare estraibile Ortholite X40 016 ESD, soletta in lamina tessile certificata antiperforazione, cambriante anti-torsione, sottopuntale a ferro di cavallo, intersuola in poliuretano ultraleggero ESD, ammortizzatore MASTER BALANCE in PU poliuretano ad alta tenacità e densità bilanciata, suola XTRAIL GRIP in TPU ESD con paratacco e parapunta.

i Fiore Bovino

◐ 39 - 40 - 41 - 41,5 - 42 - 42,5 - 43 - 43,5 - 44 - 44,5 - 45 - 46 - 47 - 48

🇮🇹 1

€ SU RICHIESTA





BL



KA

SCARPE BASSE DI SICUREZZA DA UOMO

IN CROSTA BOVINA

**PUNTALE IN
ALLUMINIO**



NE



SG

LOW SCAMOSCIATA

Scarpa di sicurezza bassa da uomo, tomaia in crosta traforata idrorepellente e traspirante, fodera interna (per tutta la superficie interna) traspirante e resistente all'abrasione, 1+1 occhielli metalfree e 6+6 fori passalacci rinforzati, inserti riflettenti nel paratacco e nel lato esterno della punta, puntale in alluminio pressofuso, plantare estraibile Ortholite X40 016 ESD, soletta in lamina tessile certificata antiperforazione, cambione anti-torsione, sottopuntale a ferro di cavallo, intersuola in poliuretano ultraleggero ESD, ammortizzatore MASTER BALANCE in PU polietere ad alta tenacità e densità bilanciata, suola XTRAIL GRIP in TPU ESD con paratacco e parapunta.



Crosta Bovina



39 - 40 - 41 - 41,5 - 42 - 42,5 - 43 - 43,5 - 44 - 44,5 - 45 - 46 - 47 - 48



1



SU RICHIESTA



BL



KA/MI



KA/SA



SCARPE DI SICUREZZA BASSE DA UOMO

IN CROSTA BOVINA

OCCHIELLI 6+6

SG/LG



NE



LOW CORDURA

Scarpa di sicurezza bassa da uomo, tomaia in crosta idrorepellente con inserti in tessuto tecnico traspirante, fodera interna (per tutta la superficie interna) traspirante e resistente all'abrasione, 6+6 occhielli metalfree, inserto riflettente nel paratacco, puntale in alluminio pressofuso, plantare estraibile Ortholite X40 016 ESD, soletta in lamina tessile certificata antiperforazione, cambrione antitorsione, sottopuntale a ferro di cavallo, intersuola in poliuretano ultraleggero ESD, ammortizzatore MASTER BALANCE in PU polietere ad alta tenacità e densità bilanciata, suola XTRAIL GRIP in TPU ESD con paratacco e parapunta..

i Crosta Bovina + Tessuto Tecnico

o 39 - 40 - 41 - 41,5 - 42 - 42,5 - 43 - 43,5 - 44 - 44,5 - 45 - 46 - 47 - 48

1

€ SU RICHIESTA



SG/NE





CAPPELLI

promosolution
2021|2022

CAPPELLO GOLF 5 PANNELLI



AR

NE



BI



VE



BL



BO



GR



VF



RY



RO



EC



VM



AZ



GI



AY 7370 GOLF ADULTO

Cappello 5 pannelli, fascia tergisudore, occhielli ricamati, frontale rinforzato, visiera rigida sagomata, regolatore misura in velcro, colori reattivi.

i 100% cotone drill 108/58

◐ Taglia Unica

👤 50/200

€ 1,98

CAPPELLO BAMBINO

5 Pannelli

Regolatore misura in velcro

BI

VE



VM



RO



AR



GI



BL



RY



NE



AY 7369 GOLF BAMBINO

Cappello 5 pannelli, fascia tergisudore, occhielli ricamati, frontale rinforzato, visiera rigida sagomata, regolatore misura in velcro, colori reattivi.



100% cotone drill 108/58



Taglia Unica



50/200



1,98



RY

CAPPELLO SANDWICH 5 PANNELLI

Visiera Bordata



BL



GI

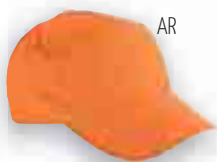

AR



RO

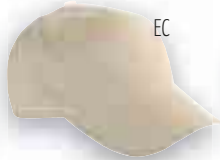

EC



NE



GR

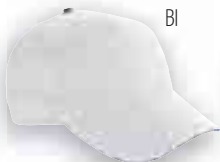

BI



VF



VE



AY 7397 SANDWICH

Cappello 5 pannelli, fascia tergisudore, occhielli ricamati, frontale rinforzato, visiera rigida sagomata e bordata, regolatore misura in velcro, colori reattivi.

i 100% cotone drill 108/58

o Taglia Unica

u 50/200

€ 2,07





CAPPELLO ITALY

visiera bordata

BANDIERINA ITALIA RICAMATA

BL



RY



BI



NE



VE



RO



AY 7377 ITALY

Cappello 5 pannelli, con bandierina Italia ricamata lateralmente, fascia tergisudore, occhielli ricamati, frontale rinforzato, visiera rigida sagomata e bordata, regolatore misura in velcro, colori reattivi.



100% cotone drill 108/58



Taglia Unica



50/200



2,46



BI/VE



BI/BL



BI/RY



BI/RO



BI/AR

BI/VM



CAPPELLO 5 PANNELLI

AY 7375 ESTORIL

Cappellino 5 pannelli, occhielli e bordo visiera a contrasto, fascia tergisudore, visiera rigida sagomata, regolatore misura in velcro, misto cotone e poliestere adatto alla sublimazione.

 Cotone + Poliestere

 Taglia Unica

 50/200

 1,98

adatto alla sublimazione



CAPPELLO GOLF 5 PANNELLI



AR

cotone pesante



VM



NE



BI



BL



RY

AY 7394 SANDWICH WINTER

HEAVY COTTON 5 pannelli in cotone pesante heavy brushed, visiera rigida sagomata, regolatore misura posteriore in velcro, taglia unica.

i Cotone pesante

o Taglia Unica

u 50/200

€ 3,87



CAPPELLO 5 PANNELLI occhielli ricamati

Segmenti posteriori in rete



RO



BI







NE



BL

AY 7380 MESH

Cappello 5 pannelli, fascia tergisudore, occhielli ricamati, frontale rinforzato, visiera rigida sagomata e bordata, regolatore misura in velcro, segmenti posteriori in rete.

-  Cotone + Poliestere
-  Taglia Unica
-  50/200
-  **3,54**



CAPPELLO MIMETICO

AY 7379 HUNTING

Cappellino mimetico, visiera rigida sagomata, regolatore misura in velcro.





-  100% cotone drill
-  Taglia Unica
-  50/200
-  **3,54**



CAPPELLINO MIRAMARE

AY 7400 MIRAMARE

Cappellino miramare 100% cotone.

-  100% cotone
-  Ø 25 cm
-  50/300
-  **2,22**



FOULARD UNISEX

ADATTO ALLA SUBLIMAZIONE

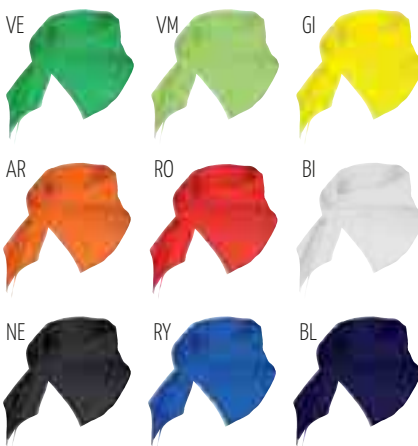
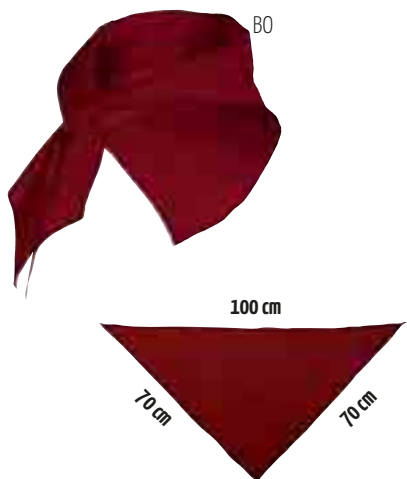

AY 7398 FOULARD

Foulard uomo/donna di forma triangolare tutto cotone, adatto alla sublimazione.

- 100% Poliestere - 65 gr/mq
- 100 x H. 50 cm
-
- 100/200
- 1,13**



Bandana



AY 7401 BANDANA

- Cotone + Poliestere
- Taglia Unica
- 100/500
- 1,95**

AY 7403 FASCIA SCALDACOLLO

Trasformabile in cappello grazie alla coulisse.

i Pile - 200 gr/mq

◐ Taglia Unica

👤 50/200

€ 2,07



FASCIA SCALDACOLLO



AY 7403-E FASCIA SCALDACOLLO

Trasformabile in cappello grazie alla coulisse.
Con etichetta.

i Pile - 200 gr/mq

◐ Taglia Unica

👤 50/200





€ 2,07



RO

AY 7427
CAPPELLINO

In poliestere pile 200 gr.

-  Poliestere Pile - 200 gr/mq
-  Taglia Unica
-  50/200
-  **2,34**

GR



BL



NE



BL



NE







GR



RO

AY 7427-E
CAPPELLINO

In poliestere pile 200 gr.

-  Poliestere Pile - 200 gr/mq
-  Taglia Unica
-  50/200
-  **2,34**

**AY 7425
CAPPELLINO**

In poliestere/acrilico 75 gr.

i 100% Acrilico - 75 gr/mq**◐** Taglia Unica**◑** 20/200**€** 2,58

RY



RO



NE



GR



BL



RY



RO



NE



GR



BL

**AY 7425-E
CAPPELLINO**

In poliestere/acrilico 75 gr.

i 100% Acrilico - 75 gr/mq**◐** Taglia Unica**◑** 20/200**€** 2,58